

VANCOUVER

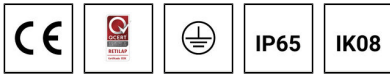

Contemporary urban lighting furniture.
Open-sided, three lattice pattern options
or your bespoke design.

Luminaire Structure

- Die-cast aluminium housing
- Extruded aluminium column
- Pre-treated before powder coating ensuring high corrosion resistance
- Single cable entry
- One IP68 connector supplied with 0.2 m of 3x1.0 sqmm outdoor cable
- Stainless steel fasteners in grade 304 with zinc flake coating (ZFC)
- Durable silicone rubber gasket
- Clear toughened glass
- High-efficiency optical reflector or high-efficiency polycarbonate lens
- Integral control gear

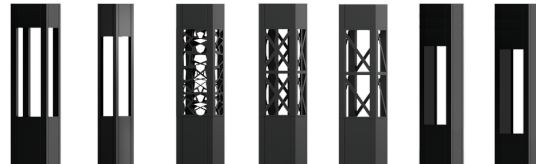

Feature

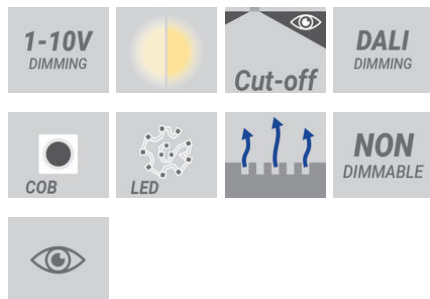

Light symbol

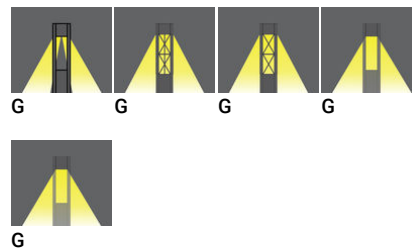

Product colour



Special finishes upon request



We reserve the right to make technical and design changes.

01:20, 16-05-2022

<https://www.ligman.com/vancouver-bollards-va-bo3/>

Europe
LIGMAN EUROPE s.r.o.
VGP Park Ústí nad Labem
P 2 120
40317, Přestanov
Czech Republic
+420 477 071 500
sales.cz@ligman.com

ASIA PACIFIC
LIGMAN Lighting Co.,Ltd.
17/2 Moo4 Monthong
Bangnampreaw
24150, Chachoengsao
Thailand
+66 2 108 6700
info@ligman.com

VANCOUVER

Technical information

	Model number	Light source	Power	Lumen	Optic	CCT / CRI	Dimming type	Weight	
120x120 mm - 600 mm - No decorative pattern									
VANCOUVER 31	VA-10101	1 LED	7 W	190 - 200 lm	G [34°]	3000K CRI80, 4000K CRI80	On/Off	12 kg	
VANCOUVER 38	VA-10141	1 LED	8 W	90 - 95 lm	G [107°]	3000K CRI80, 4000K CRI80	On/Off	4.40 kg	
160x160 mm - 1000 mm - No decorative pattern									
VANCOUVER 4	VA-10011	1 COB	14 W	1066 - 1122 lm	G [67°]	3000K, 4000K	DALI, 1-10V, On/Off	8.2 kg	
VANCOUVER 33	VA-10051	1 COB	15 W	1007 - 1083 lm	G [143°]	3000K CRI80, 4000K CRI80	DALI, 1-10V, On/Off	11 kg	
VANCOUVER 39	VA-10151	1 COB	15 W	397 - 418 lm	G [67°]	3000K CRI80, 4000K CRI80	DALI, 1-10V, On/Off	10.2 kg	
240x240 mm - 1000 mm - Decorative pattern type 1									
VANCOUVER 11	VA-10021	1 COB	21 W	563 - 570 lm	G [65°]	3000K CRI80, 4000K CRI80	DALI, 1-10V, On/Off	15.8 kg	
VANCOUVER 35	VA-10071	1 COB	21 W	981 - 1032 lm	G [134°]	3000K CRI80, 4000K CRI80	DALI, 1-10V, On/Off	15.8 kg	
240x240 mm - 1000 mm - Decorative pattern type 2									
VANCOUVER 12	VA-10031	1 COB	21 W	459 - 490 lm	G [56°]	3000K CRI80, 4000K CRI80	DALI, 1-10V, On/Off	15.8 kg	
VANCOUVER 36	VA-10072	1 COB	21 W	1461 - 1571 lm	G [134°]	3000K CRI80, 4000K CRI80	DALI, 1-10V, On/Off	15.8 kg	
240x240 mm - 1000 mm - Decorative pattern type 3									
VANCOUVER 13	VA-10041	1 COB	21 W	657 - 704 lm	G [58°]	3000K CRI80, 4000K CRI80	DALI, 1-10V, On/Off	15.8 kg	
VANCOUVER 37	VA-10073	1 COB	21 W	1461 - 1571 lm	G [134°]	3000K CRI80, 4000K CRI80	DALI, 1-10V, On/Off	4.40 kg	
240x240 mm - 1000 mm - No decorative pattern									
VANCOUVER 3	VA-10001	1 COB	21 W	1255 - 1270 lm	G [76°]	3000K CRI80, 4000K CRI80	DALI, 1-10V, On/Off	11.0 kg	
VANCOUVER 34	VA-10061	1 COB	21 W	1461 - 1571 lm	G [134°]	3000K CRI80, 4000K CRI80	DALI, 1-10V, On/Off	11 kg	
VANCOUVER 40	VA-10161	1 COB	21 W	600 - 635 lm	G [76°]	3000K CRI80, 4000K CRI80	DALI, 1-10V, On/Off	14 kg	

Accessories

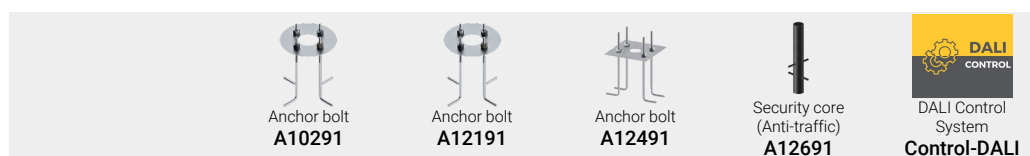

We reserve the right to make technical and design changes.

01:20, 16-05-2022

<https://www.ligman.com/vancouver-bollards-va-bo3/>

Europe
LIGMAN EUROPE s.r.o.
VGP Park Ústí nad Labem
P 2 120
40317, Přestanov
Czech Republic
+420 477 071 500
sales.cz@ligman.com

ASIA PACIFIC
LIGMAN Lighting Co.,Ltd.
17/2 Moo4 Monthong
Bangnampreaw
24150, Chachoengsao
Thailand
+66 2 108 6700
info@ligman.com

VANCOUVER

VA-10001	•		•	•
VA-10011		•		•
VA-10021	•		•	•
VA-10031	•		•	•
VA-10041	•		•	•
VA-10051		•		•
VA-10061	•		•	•
VA-10071	•		•	•
VA-10072	•		•	•
VA-10073	•		•	•
VA-10101			•	
VA-10141			•	
VA-10151		•		•
VA-10161	•		•	•

We reserve the right to make technical and design changes.

01:20, 16-05-2022

<https://www.ligman.com/vancouver-bollards-va-bo3/>

Europe
LIGMAN EUROPE s.r.o.
VGP Park Ústí nad Labem
P 2 120
40317, Přestanov
Czech Republic
+420 477 071 500
sales.cz@ligman.com

ASIA PACIFIC
LIGMAN Lighting Co.,Ltd.
17/2 Moo4 Monthong
Bangnampreaw
24150, Chachoengsao
Thailand
+66 2 108 6700
info@ligman.com

VANCOUVER

VANCOUVER

VANCOUVER 3,34

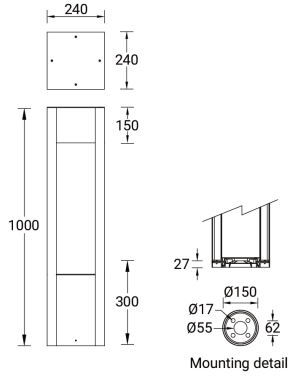

VANCOUVER 4,33

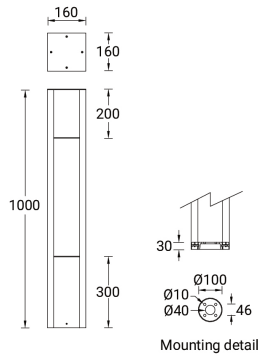

VANCOUVER 31

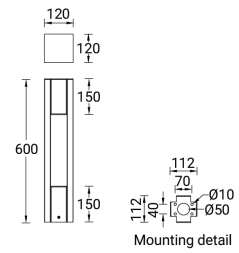

VANCOUVER 11,35

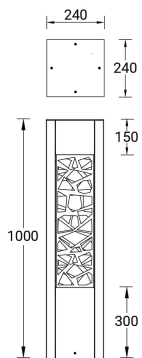

VANCOUVER 12,36

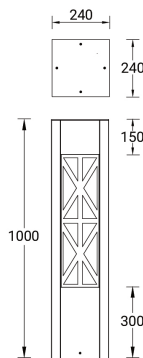

VANCOUVER 13,37

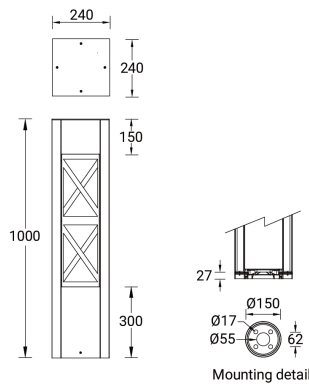

VANCOUVER 40

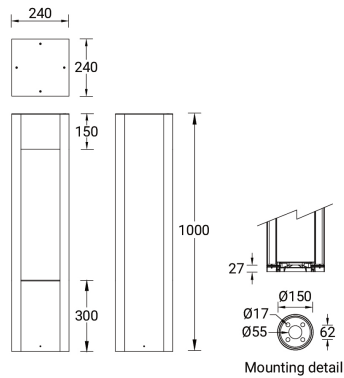

VANCOUVER 39

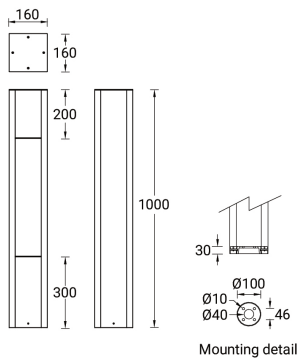

VANCOUVER 38

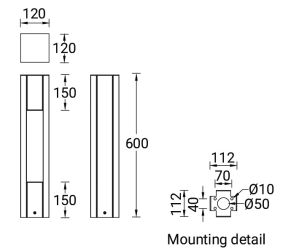

We reserve the right to make technical and design changes.

01:20, 16-05-2022

<https://www.ligman.com/vancouver-bollards-va-bo3/>

Europe
LIGMAN EUROPE s.r.o.
VGP Park Ústí nad Labem
P 2 120
40317, Přestanov
Czech Republic
+420 477 071 500
sales.cz@ligman.com

ASIA PACIFIC
LIGMAN Lighting Co.,Ltd.
17/2 Moo4 Monthong
Bangnampreaw
24150, Chachoengsao
Thailand
+66 2 108 6700
info@ligman.com

VANCOUVER



VANCOUVER
Pillar luminaires

Compact decorative landscape way-finding. Minimalist solutions delivering a play of illuminate patterns.

<https://www.ligman.com/vancouver-pillar-luminaires-van-bo3/>



VANCOUVER
Light columns

Total urban realm lighting solution. Optional heights, accent projectors, accessories and decorative lattice panels.

<https://www.ligman.com/vancouver-light-columns-va-li3/>

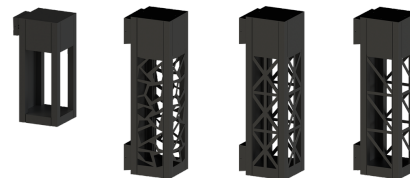

VANCOUVER
Surface facade luminaires

Contemporary urban lighting furniture. Open-sided, three lattice pattern options or your bespoke design.

<https://www.ligman.com/vancouver-surface-facade-luminaires-va-su3/>