

# LIGHT LINEAR PT



Area distribution bollard-integrated projectors. Stylish but technically precise area lighting solutions as part of a large flexible family.

## Luminaire Structure

- Die-cast aluminium housing
- Extruded aluminium column
- Pre-treated before powder coating ensuring high corrosion resistance
- Single cable entry
- One IP68 connector supplied with 0.2 m of 3x1.0 sqmm outdoor cable
- Stainless steel fasteners in grade 304 with zinc flake coating (ZFC)
- Durable silicone rubber gasket
- High-efficiency PMMA lens
- Clear toughened glass
- Integral control gear



## Feature

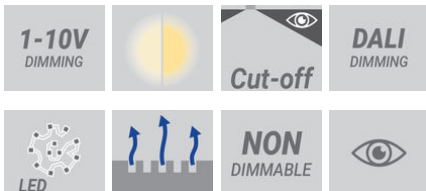

## Light symbol

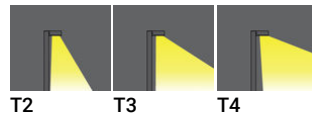

## Product colour



## Special finishes upon request

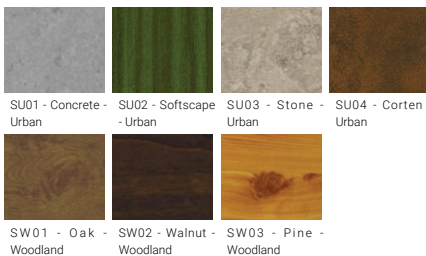

We reserve the right to make technical and design changes.

01:19, 16-05-2022











<https://www.ligman.com/light-linear-pt-bollards-li-bo3/>

**Europe**  
LIGMAN EUROPE s.r.o.  
VGP Park Ústí nad Labem  
P 2 120  
40317, Přestanov  
Czech Republic  
+420 477 071 500  
[sales.cz@ligman.com](mailto:sales.cz@ligman.com)





**ASIA PACIFIC**  
LIGMAN Lighting Co.,Ltd.  
17/2 Moo4 Monthong  
Bangnampreaw  
24150, Chachoengsao  
Thailand  
+66 2 108 6700  
[info@ligman.com](mailto:info@ligman.com)

# LIGHT LINEAR PT

## Technical information

	Model number	Light source	Power	Lumen	Optic	CCT / CRI	Dimming type	Weight	
<b>200x80 mm - 1000 mm - 1 side</b>									
LIGHT LINEAR PT 1	<b>LI-10021</b>	12 LED	28 W	2950 - 3169 lm	T2 [143°x56°], T3 [142°x70°], T4 [100°x76°]	3000K CRI80, 4000K CRI80	DALI, 1-10V, On/Off	11.2 kg	  
LIGHT LINEAR PT 1	<b>LI-10022</b>	24 LED	54 W	5793 - 6240 lm	T2 [142°x53°], T3 [141°x69°], T4 [99°x79°]	3000K CRI80, 4000K CRI80	On/Off	11.8 kg	 
<b>200x80 mm - 1000 mm - 2 sides</b>									
LIGHT LINEAR PT 2	<b>LI-10031</b>	12 LED	54 W	5900 - 6338 lm	T2 [143°x56°], T3 [142°x70°], T4 [100°x76°]	3000K CRI80, 4000K CRI80	On/Off	14.9 kg	  
LIGHT LINEAR PT 2	<b>LI-10032</b>	24 LED	108 W	11002 - 12386 lm	T2 [142°x53°], T3 [141°x69°], T4 [99°x79°]	3000K CRI80, 4000K CRI80	DALI, 1-10V, On/Off	15.8 kg	 

## Accessories

	 Anchor bolt <b>A11191</b>	 Security core (Anti-traffic) <b>A13391</b>	 Motion sensor - PIR - DALI - Lunatone - DALI CS Corridor - IP65 <b>A69291</b>	 Lunatone - DALI PS2 30mA <b>A69391</b>	 DALI Control System <b>Control-DALI</b>
LI-10021	•	•	•	•	•
LI-10022	•	•			
LI-10031	•	•			
LI-10032	•	•	•	•	•

We reserve the right to make technical and design changes.

01:19, 16-05-2022

<https://www.ligman.com/light-linear-pt-bollards-li-bo3/>

**Europe**  
LIGMAN EUROPE s.r.o.  
VGP Park Ústí nad Labem  
P 2 120  
40317, Přestanov  
Czech Republic  
+420 477 071 500  
[sales.cz@ligman.com](mailto:sales.cz@ligman.com)

**ASIA PACIFIC**  
LIGMAN Lighting Co.,Ltd.  
17/2 Moo4 Monthong  
Bangnampreaw  
24150, Chachoengsao  
Thailand  
+66 2 108 6700  
[info@ligman.com](mailto:info@ligman.com)

# LIGHT LINEAR PT

## LIGHT LINEAR PT Bollards

### LIGHT LINEAR PT 1

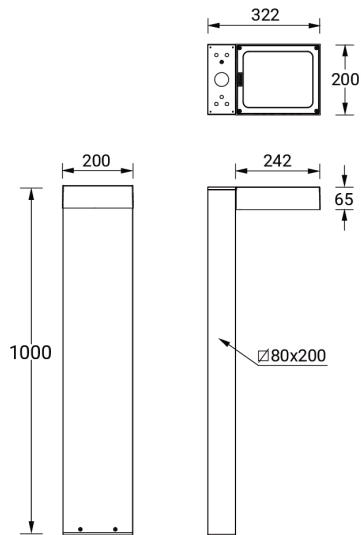

### LIGHT LINEAR PT 2

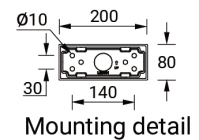
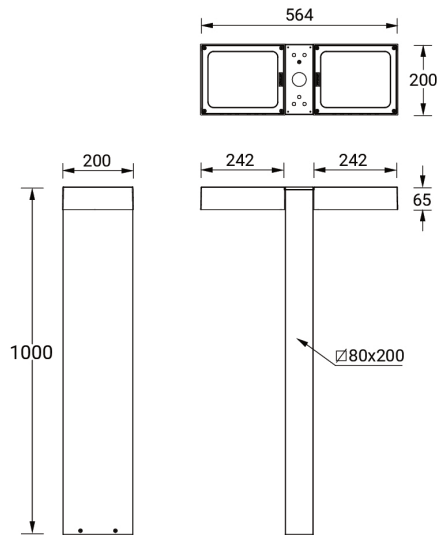

# LIGHT LINEAR PT



LIGHT LINEAR PT  
**Surface facade luminaires**

Area distribution wall-mounted projectors. Stylish but technically precise area lighting solutions as part of a large flexible family.

<https://www.ligman.com/light-linear-pt-surface-facade-luminaires-li-su3/>



LIGHT LINEAR PT  
**Street & area lighting luminaires**

Public realm contemporary column family. Stylish but technically precise area lighting solutions as part of a large flexible family.

<https://www.ligman.com/light-linear-pt-street-area-lighting-luminaires-lig-st3/>



LIGHT LINEAR PT-X  
**Street & area lighting luminaires**

High output and performance range within the LIGHT LINEAR family. Stylish contemporary solution for major roads and large area applications.

<https://www.ligman.com/light-linear-pt-x-street-area-lighting-luminaires-ligx-st3/>