

POLO+ ZERO

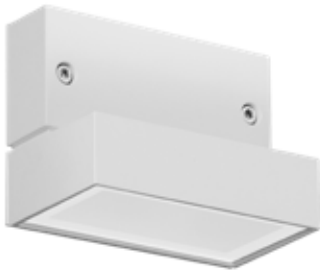

- GR-94 / Metallic grey / Textured
- AN-96 / Anthracite gray / Textured
- WH-87 / White / Textured



YouTube video



Range of recessed luminaires LED for wall mounted applications, comprising:

- Painted die-cast aluminium housing
- Diffusor made of extra clear, flat glass, tempered, markings with serigraphy, internally ice etched
- Silicone gasket
- Mains voltage 220-240V 50/60Hz LED module protected against surges up to 500V
- Stainless steel locking screws
- Also installable with light aimed upwards
- Complying with the recommendations for glare control and upward light pollution



POLO+ ZERO S/EW

IK05 0,70J xx3

LAMPHOLDER	WATTAGE	CLASS	CRI	KELVIN	COS φ ≥ 0.9	OPTIC	OPTIC BEAM	LIGHTSOURCE LUMEN OUTPUT	LUMINAIRE LUMEN OUTPUT	L	B	LIFETIME	COLOUR/ RAL	PART NUMBER
Power LED 220-240 V 50/60 Hz														
LED	6,5 W	I	80	4000	•	S/EW	-	742 lm	271 lm	70	10	35000 h	●	304544
LED	6,5 W	I	80	3000	•	S/EW	-	675 lm	237 lm	70	10	35000 h	●	304543
LED	6,5 W	I	80	4000	•	S/EW	-	742 lm	271 lm	70	10	35000 h	●	304546
LED	6,5 W	I	80	3000	•	S/EW	-	675 lm	237 lm	70	10	35000 h	●	304545
LED	6,5 W	I	80	4000	•	S/EW	-	742 lm	271 lm	70	10	35000 h	○	304548
LED	6,5 W	I	80	3000	•	S/EW	-	675 lm	237 lm	70	10	35000 h	○	304547

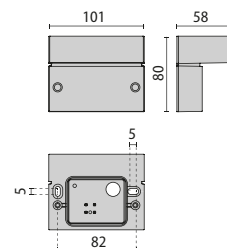

POLO+ 1



- GR-94 / Metallic grey / Textured
- AN-96 / Anthracite gray / Textured
- WH-87 / White / Textured



Range of recessed luminaires LED for wall mounted applications, comprising:

- Painted die-cast aluminium housing
- Diffusor made of extra clear, flat glass, tempered, markings with serigraphy, internally ice etched
- Silicone gasket
- Mains voltage 220-240V 50/60Hz LED module protected against surges up to 500V
- Stainless steel locking screws
- Complying with the recommendations for glare control and upward light pollution



POLO+ 1 S/EW

IK05 0,70J xx3

LAMPHOLDER	WATTAGE	CLASS	CRI	KELVIN	COS φ ≥ 0,9	OPTIC	OPTIC BEAM	LIGHTSOURCE LUMEN OUTPUT	LUMINAIRE LUMEN OUTPUT	L	B	LIFETIME	COLOUR/ RAL	PART NUMBER
LED	11,5 W	I	80	4000	•	S/EW	-	1485 lm	488 lm	70	10	35000 h	●	304550
LED	11,5 W	I	80	3000	•	S/EW	-	1350 lm	474 lm	70	10	35000 h	●	304549
LED	11,5 W	I	80	4000	•	S/EW	-	1485 lm	488 lm	70	10	35000 h	●	304552
LED	11,5 W	I	80	3000	•	S/EW	-	1350 lm	474 lm	70	10	35000 h	●	304551
LED	11,5 W	I	80	4000	•	S/EW	-	1485 lm	488 lm	70	10	35000 h	○	304554
LED	11,5 W	I	80	3000	•	S/EW	-	1350 lm	474 lm	70	10	35000 h	○	304553

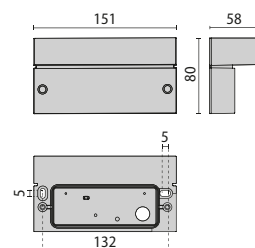

POLO+ 2



- GR-94 / Metallic grey / Textured
- AN-96 / Anthracite gray / Textured
- WH-87 / White / Textured



YouTube video



Range of recessed luminaires LED for wall mounted applications, comprising:

- Painted die-cast aluminium housing
- Diffusor made of extra clear, flat glass, tempered, markings with serigraphy, internally ice etched
- Silicone gasket
- Mains voltage 220-240V 50/60Hz LED module protected against surges up to 500V
- Stainless steel locking screws
- Complying with the recommendations for glare control and upward light pollution
- POLO+2/I version including on/off switch



POLO+ 2 A/EW

IK05 0,70J xx3

LAMPHOLDER	WATTAGE	CLASS		CRI	KELVIN	COS Φ ≥ 0,9	OPTIC	OPTIC BEAM	LIGHTSOURCE LUMEN OUTPUT	LUMINAIRE LUMEN OUTPUT	L	B	LIFETIME	COLOUR/ RAL	PART NUMBER
Power LED 220-240 V 50/60 Hz															
LED	11,5 W	I		80	4000	•	A/EW	-	1485 lm	451 lm	70	10	35000 h	●	304556
LED	11,5 W	I		80	3000	•	A/EW	-	1350 lm	438 lm	70	10	35000 h	●	304555
LED	11,5 W	I		80	4000	•	A/EW	-	1485 lm	451 lm	70	10	35000 h	●	304558
LED	11,5 W	I		80	3000	•	A/EW	-	1350 lm	438 lm	70	10	35000 h	●	304557
LED	11,5 W	I		80	4000	•	A/EW	-	1485 lm	451 lm	70	10	35000 h	○	304560
LED	11,5 W	I		80	3000	•	A/EW	-	1350 lm	438 lm	70	10	35000 h	○	304559

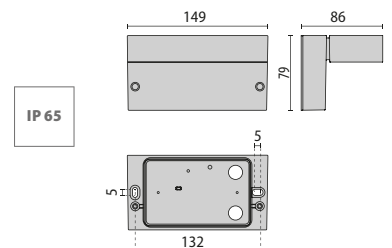

POLO+ 2/I A/EW

IK05 0,70J xx3

LAMPHOLDER	WATTAGE	CLASS		CRI	KELVIN	COS Φ ≥ 0,9	OPTIC	OPTIC BEAM	LIGHTSOURCE LUMEN OUTPUT	LUMINAIRE LUMEN OUTPUT	L	B	LIFETIME	COLOUR/ RAL	PART NUMBER
Power LED 220-240 V 50/60 Hz															
LED	11,5 W	I		80	4000	•	A/EW	-	1485 lm	451 lm	70	10	35000 h	●	304974
LED	11,5 W	I		80	3000	•	A/EW	-	1350 lm	438 lm	70	10	35000 h	●	304973
LED	11,5 W	I		80	4000	•	A/EW	-	1485 lm	451 lm	70	10	35000 h	○	304976
LED	11,5 W	I		80	3000	•	A/EW	-	1350 lm	438 lm	70	10	35000 h	○	304975



POLO+ 3



- GR-94 / Metallic grey / Textured
- AN-96 / Anthracite gray / Textured
- WH-87 / White / Textured



YouTube video



Range of recessed luminaires LED for wall mounted applications, comprising:

- Painted die-cast aluminium housing
- Diffusor made of extra clear, flat glass, tempered, markings with serigraphy, internally ice etched
- Silicone gasket
- Mains voltage 220-240V 50/60Hz LED module protected against surges up to 500V
- Stainless steel locking screws
- Complying with the recommendations for glare control and upward light pollution



POLO+ 3 A/EW

IK05 0,70J xx3

LAMPHOLDER	WATTAGE	CLASS	CRI	KELVIN	COS φ ≥ 0,9	OPTIC	OPTIC BEAM	LIGHTSOURCE LUMEN OUTPUT	LUMINAIRE LUMEN OUTPUT	L	B	LIFETIME	COLOUR/ RAL	PART NUMBER
Power LED 220-240 V 50/60 Hz														
LED	17 W	I	80	4000	•	A/EW	-	2225 lm	673 lm	70	10	35000 h	●	304562
LED	17 W	I	80	3000	•	A/EW	-	2025 lm	620 lm	70	10	35000 h	●	304561
LED	17 W	I	80	4000	•	A/EW	-	2225 lm	673 lm	70	10	35000 h	●	304564
LED	17 W	I	80	3000	•	A/EW	-	2025 lm	620 lm	70	10	35000 h	●	304563
LED	17 W	I	80	4000	•	A/EW	-	2225 lm	673 lm	70	10	35000 h	○	304566
LED	17 W	I	80	3000	•	A/EW	-	2025 lm	620 lm	70	10	35000 h	○	304565

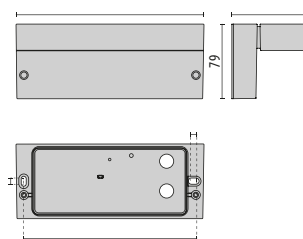

POLO

design by ROBERTO FIORATO



- GR-94 / Metallic grey / Textured
- BK-81 / Black / Textured
- IVORY-10 / Ivory / Textured

Wall and pole mounted luminaire for 45° directed light for indoor and outdoor, comprising:

- Technopolymer housing
- Pressed glass diffuser with internal pattern, white painted internally
- Stainless steel locking screws
- The securing space allows installation on the recessed boxes
- Passive infra-red motion sensor
- Only for resistance load: max 150 W, min 40 W
- Adjustable operation time (45 s to 10 min)
- Detection distance: adjustable between 4 m and 12 m
- Built-in photocell set at 60± 20 lux
- Recommended installation height: 2.1 m
- Detection angle 110° (non adjustable)
- 960° PC versions available on request
- POLO/I and POLO 2/I versions including on/off switch



POLO

POLO /I

POLO 2

POLO 2 /I

POLO 2 DETEK

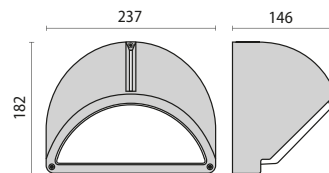
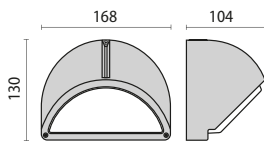

Package size

 POLO
21,5 x 29 x 59,5 cm
(master x 10)

 POLO 2
19 x 40,5 x 52 cm
(master x 4)

 POLO 2 DETEK
19 x 52 x 50,5 cm
(master x 4)

Fixing holes

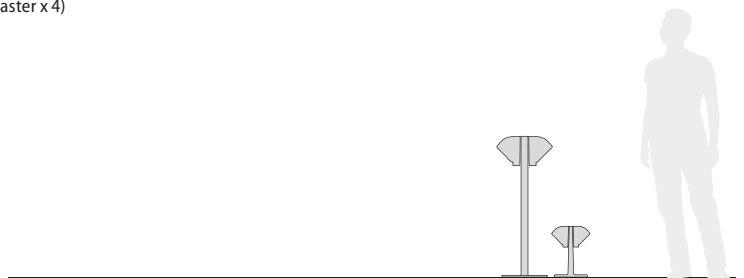
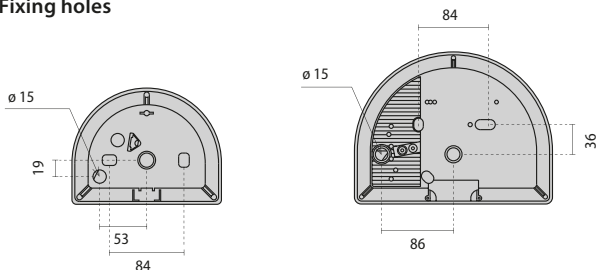

POLO

IK06 1J xx3

LAMPHOLDER	WATTAGE	CLASS		CRI	KELVIN	COS ϕ $\geq 0,9$	OPTIC	OPTIC BEAM	LIGHTSOURCE LUMEN OUTPUT	LUMINAIRE LUMEN OUTPUT	L	B	LIFETIME	COLOUR/ RAL	PART NUMBER
E14	1x40 W	II		-	-	-	S/EW	-	-	-	-	-	-	●	007699
E14	1x40 W	II		-	-	-	S/EW	-	-	-	-	-	●	007701	
E14	1x40 W	II		-	-	-	S/EW	-	-	-	-	-	●	007700	



POLO/I

IK06 1J xx3

LAMPHOLDER	WATTAGE	CLASS		CRI	KELVIN	COS ϕ $\geq 0,9$	OPTIC	OPTIC BEAM	LIGHTSOURCE LUMEN OUTPUT	LUMINAIRE LUMEN OUTPUT	L	B	LIFETIME	COLOUR/ RAL	PART NUMBER
E14	1x40 W	I		-	-	-	S/EW	-	-	-	-	-	-	●	007704
E14	1x40 W	I		-	-	-	S/EW	-	-	-	-	-	-	●	007703
E14	1x40 W	I		-	-	-	S/EW	-	-	-	-	-	-	●	007702



POLO 2

IK06 1J xx3

LAMPHOLDER	WATTAGE	CLASS		CRI	KELVIN	COS ϕ $\geq 0,9$	OPTIC	OPTIC BEAM	LIGHTSOURCE LUMEN OUTPUT	LUMINAIRE LUMEN OUTPUT	L	B	LIFETIME	COLOUR/ RAL	PART NUMBER
E27	1x75 W	II		-	-	-	S/EW	-	-	-	-	-	-	●	007935
E27	1x75 W	II		-	-	-	S/EW	-	-	-	-	-	-	●	007706
E27	1x75 W	II		-	-	-	S/EW	-	-	-	-	-	-	●	007705

Dulux EL Longlife E27 1x7W / PHILIPS PL-E E27 1x15W



POLO 2/I

IK06 1J xx3

LAMPHOLDER	WATTAGE	CLASS		CRI	KELVIN	COS ϕ $\geq 0,9$	OPTIC	OPTIC BEAM	LIGHTSOURCE LUMEN OUTPUT	LUMINAIRE LUMEN OUTPUT	L	B	LIFETIME	COLOUR/ RAL	PART NUMBER
E27	1x75 W	I		-	-	-	S/EW	-	-	-	-	-	-	●	007939
E27	1x75 W	I		-	-	-	S/EW	-	-	-	-	-	-	●	007714
E27	1x75 W	I		-	-	-	S/EW	-	-	-	-	-	-	●	007713

Dulux EL Longlife E27 1x7W / PHILIPS PL-E E27 1x15W



POLO 2 DETEK

IK06 1J xx3

LAMPHOLDER	WATTAGE	CLASS		CRI	KELVIN	COS ϕ $\geq 0,9$	OPTIC	OPTIC BEAM	LIGHTSOURCE LUMEN OUTPUT	LUMINAIRE LUMEN OUTPUT	L	B	LIFETIME	COLOUR/ RAL	PART NUMBER
E27	1x75 W	I		-	-	-	S/EW	-	-	-	-	-	-	●	007938
E27	1x75 W	I		-	-	-	S/EW	-	-	-	-	-	-	●	007712
E27	1x75 W	I		-	-	-	S/EW	-	-	-	-	-	-	●	007711



OPTIONAL ACCESSORIES

DESCRIPTION	COLOR	PART NUMBER
POLO		
Minipost	●	008101
Minipost	●	008100
Double Post	●	000501
Double Post	●	000500

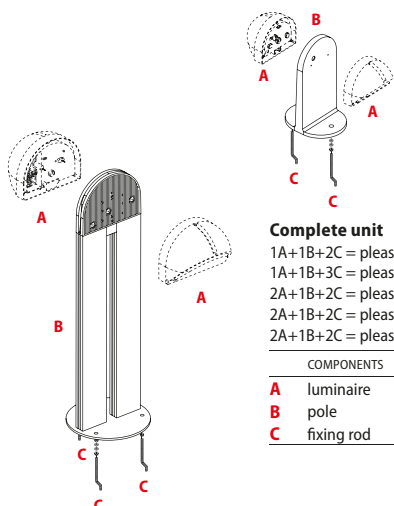

Complete unit

- 1A+1B+2C = please order 4 codes
- 1A+1B+3C = please order 5 codes
- 2A+1B+2C = please order 4 codes
- 2A+1B+2C = please order 5 codes
- 2A+1B+2C = please order 6 codes

COMPONENTS

- A** luminaire
- B** pole
- C** fixing rod

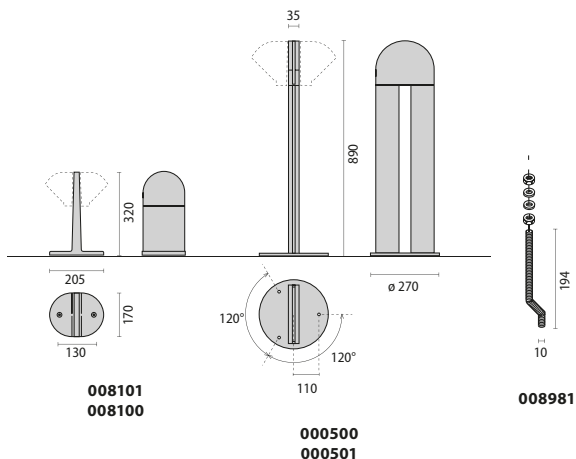

008101
008100

000500
000501

008981