

BPM Lighting®  
**FLORIDA**  
 TRIMLESS

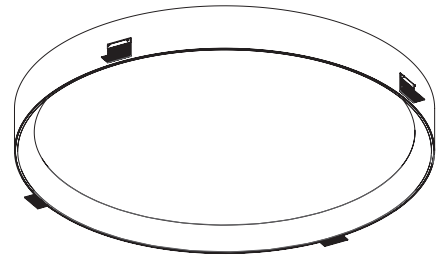

**PHOTOMETRY - FOTOMETRÍA**

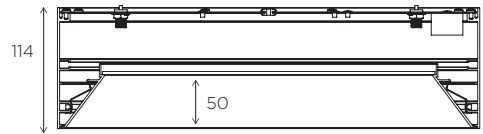
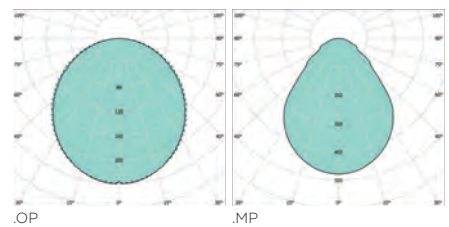

You can find all photometry data in our web.  
*Puedes encontrar todas las fotometrías en nuestra web.*

**OTHER INSTALLATION - OTRA INSTALACIÓN**

.SR / .PN

PAG. 126

.RF

PAG. 288

# FLORIDA

REF. 10190

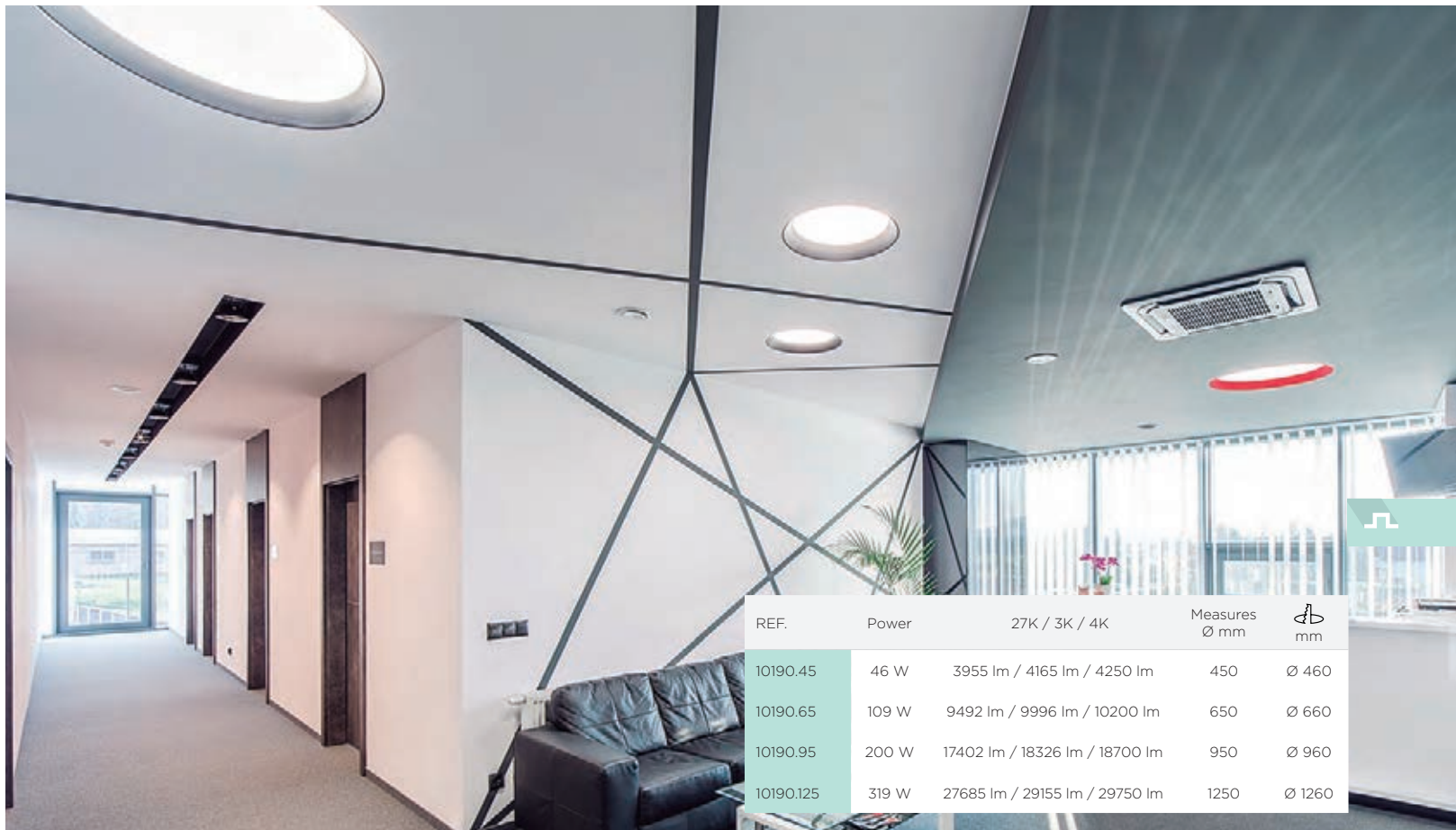

REF.	Power	27K / 3K / 4K	Measures Ø mm	dB mm
10190.45	46 W	3955 lm / 4165 lm / 4250 lm	450	Ø 460
10190.65	109 W	9492 lm / 9996 lm / 10200 lm	650	Ø 660
10190.95	200 W	17402 lm / 18326 lm / 18700 lm	950	Ø 960
10190.125	319 W	27685 lm / 29155 lm / 29750 lm	1250	Ø 1260



Configuration: REF + #			
Installation - <i>Instalación</i>			
Trimless <i>Empotrado sin marco</i>	.TR		
Color finish - <i>Acabado</i>			
White - <i>Blanco</i>	.W	Black - <i>Negro</i>	.BK
Gold - <i>Oro</i>	.G	Pink - <i>Rosa</i>	.PI
Blue - <i>Azul</i>	.BL	Aqua	.AQ
Red - <i>Rojo</i>	.RE	Flamingo - <i>Flamenco</i>	.FL
Green - <i>Verde</i>	.GR	Orange - <i>Naranja</i>	.OR
Anod. Gray - <i>Gris anod.</i>	.AG	Gold Leaf - <i>Pan de oro</i>	.GL
Silver Leaf - <i>Pan de plata</i>	.SL	Copper - <i>Cobre</i>	.CO
Optic cover - <i>Difusor</i>			
Opal	.OP	Microprismatic	.MP
Dynamic Light - <i>Luz Dinámica</i>			
Dynamic White <i>Blanco dinámico / pag. 59</i>	.DW	RGB / <i>pag. 65</i>	.RGB
Color Temperature - <i>Temperatura de color</i>			
2700K	.27K	3000K	.3K
4000K	.4K		
Dimmable options - <i>Opciones de regulación</i>			
1..10V	.D1	DALI	.DA
Push - <i>Pulsador</i>	.PU		

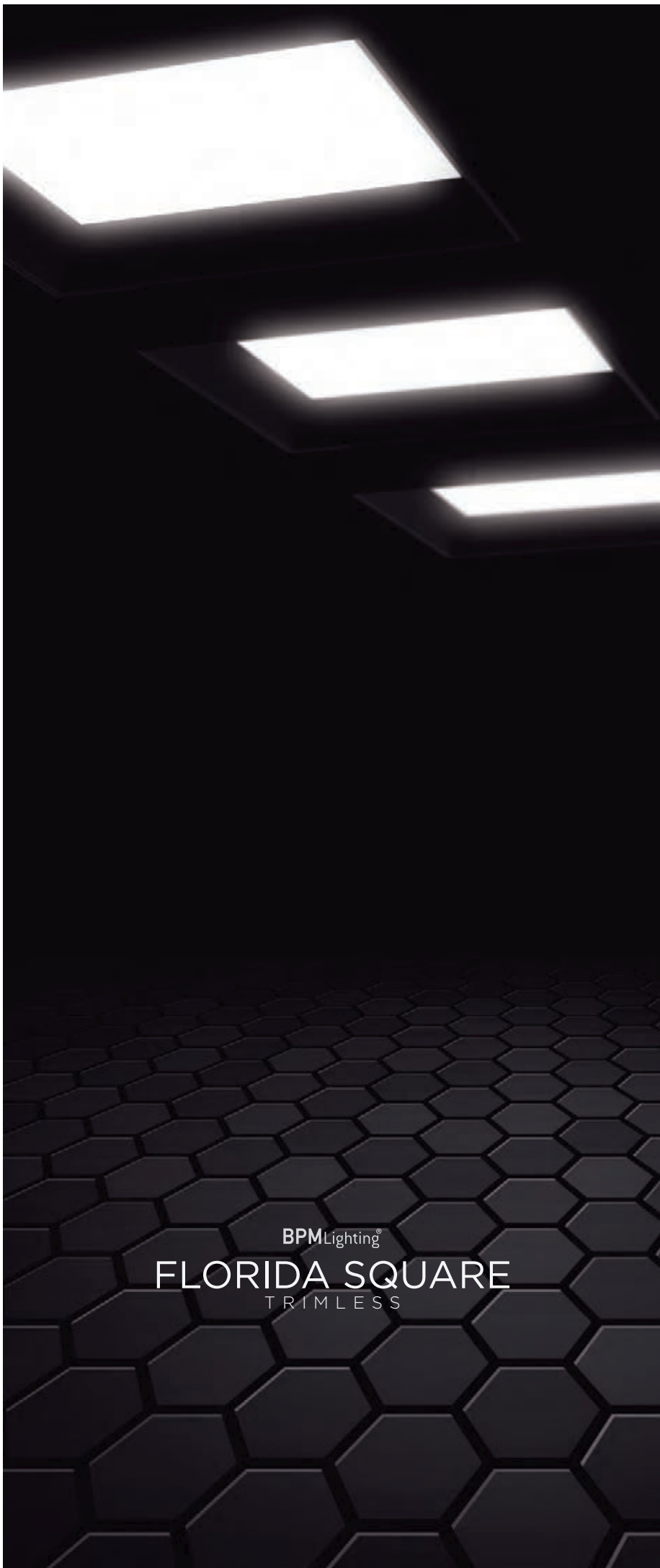

BPM<sup>Lighting</sup>  
**FLORIDA SQUARE**  
 TRIMLESS

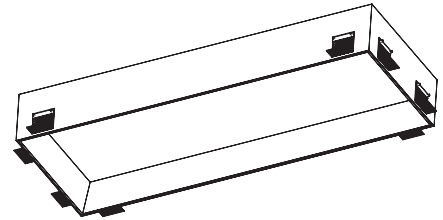
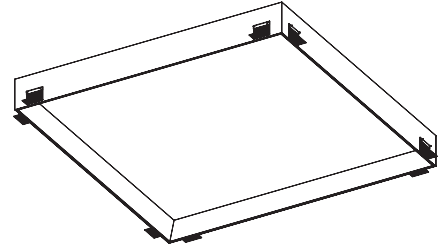
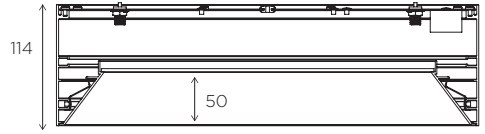

**PHOTOMETRY - FOTOMETRÍA**

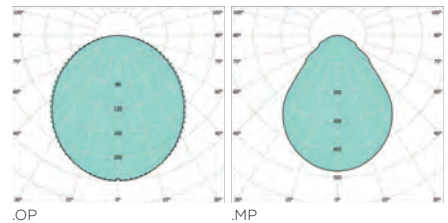

You can find all photometry data in our web.

*Puedes encontrar todas las fotometrías en nuestra web.*

**OTHER INSTALLATION - OTRA INSTALACIÓN**

.SR / .PN

PAG. 128

.RF

PAG. 290

# FLORIDA SQUARE

REF. 10191

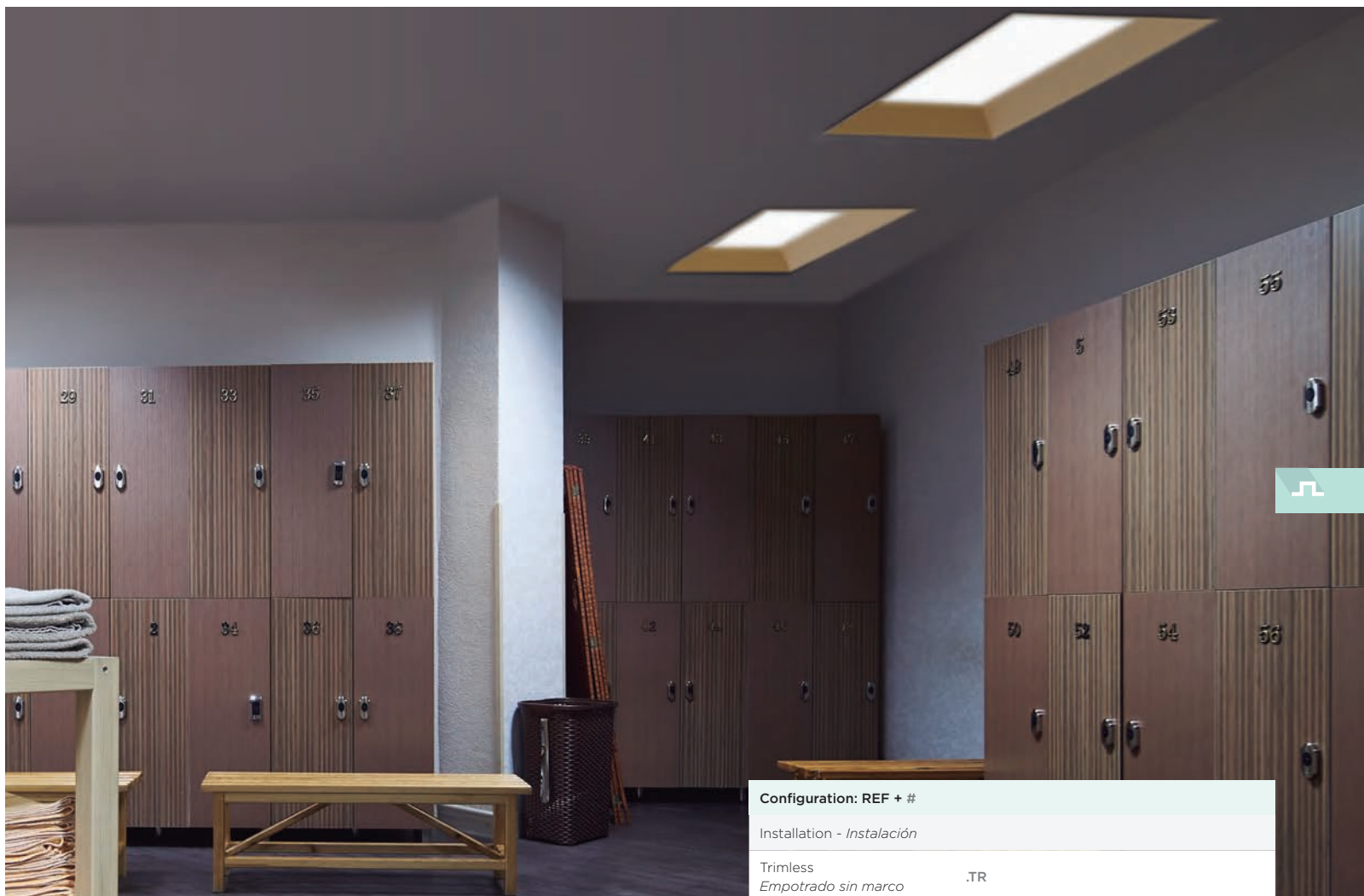

Configuration: REF + #			
Installation - <i>Instalación</i>			
Trimless <i>Empotrado sin marco</i>		.TR	
Color finish - <i>Acabado</i>			
White - <i>Blanco</i>	.W	Black - <i>Negro</i>	.BK
Gold - <i>Oro</i>	.G	Pink - <i>Rosa</i>	.PI
Blue - <i>Azul</i>	.BL	Aqua	.AQ
Red - <i>Rojo</i>	.RE	Flamingo - <i>Flamenco</i>	.FL
Green - <i>Verde</i>	.GR	Orange - <i>Naranja</i>	.OR
Anod. Gray - <i>Gris anod.</i>	.AG	Gold Leaf - <i>Pan de oro</i>	.GL
Silver Leaf - <i>Pan de plata</i>	.SL	Copper - <i>Cobre</i>	.CO
Optic cover - <i>Difusor</i>			
Opal	.OP	Microprismatic	.MP
Dynamic Light - <i>Luz Dinámica</i>			
Dynamic White <i>Blanco dinámico / pag. 59</i>	.DW	RGB / <i>pag. 65</i>	.RGB
Color Temperature - <i>Temperatura de color</i>			
2700K	.27K	3000K	.3K
4000K	.4K		
Dimmable options - <i>Opciones de regulación</i>			
1.10V	.D1	DALI	.DA
Push - <i>Pulsador</i>	.PU		

REF.	Power	27K / 3K / 4K	Measures mm	 mm
10191.35	27 W	2373 lm / 2500 lm / 2550 lm	350x350	360x360
10191.45	55 W	4746 lm / 5000 lm / 5100 lm	450x450	460x460
10191.65	109 W	9492 lm / 10000 lm / 10200 lm	650x650	660x660
10191.95	218 W	18984 lm / 20000 lm / 20400 lm	950x950	960x960
10191.125	364 W	31640 lm / 33320 lm / 34000 lm	1250x1250	1260x1260
10191.30-65	36 W	3164 lm / 3332 lm / 3400 lm	300x650	310x660
10191.30-95	55 W	4746 lm / 5000 lm / 5100 lm	300x950	310x960
10191.30-125	73 W	6328 lm / 6664 lm / 6800 lm	300x1250	310x1260
10191.30-155	91 W	7910 lm / 8330 lm / 8500 lm	300x1550	310x1560





BPMLighting®  
FLORIDA

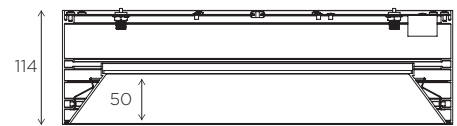
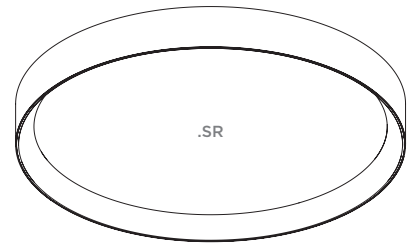
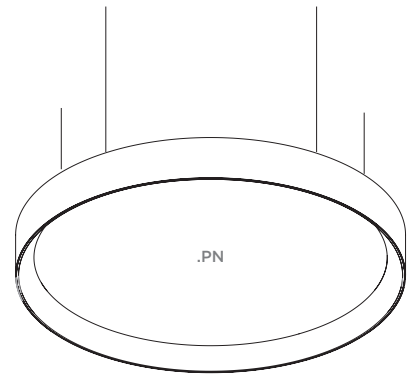

Configuration | Configuración  
Indirect light - Luz indirecta, pag. 112

CONNECTION BOX - CAJA DE CONEXIÓN pag. 422



CB03

PHOTOMETRY - FOTOMETRÍA

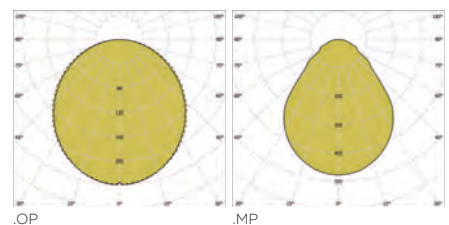

You can find all photometry data in our web.  
Puedes encontrar todas las fotometrías en nuestra web.

OTHER INSTALLATION - OTRA INSTALACIÓN

.TR

PAG. 80

.RF

PAG. 288

# FLORIDA

REF. 10190

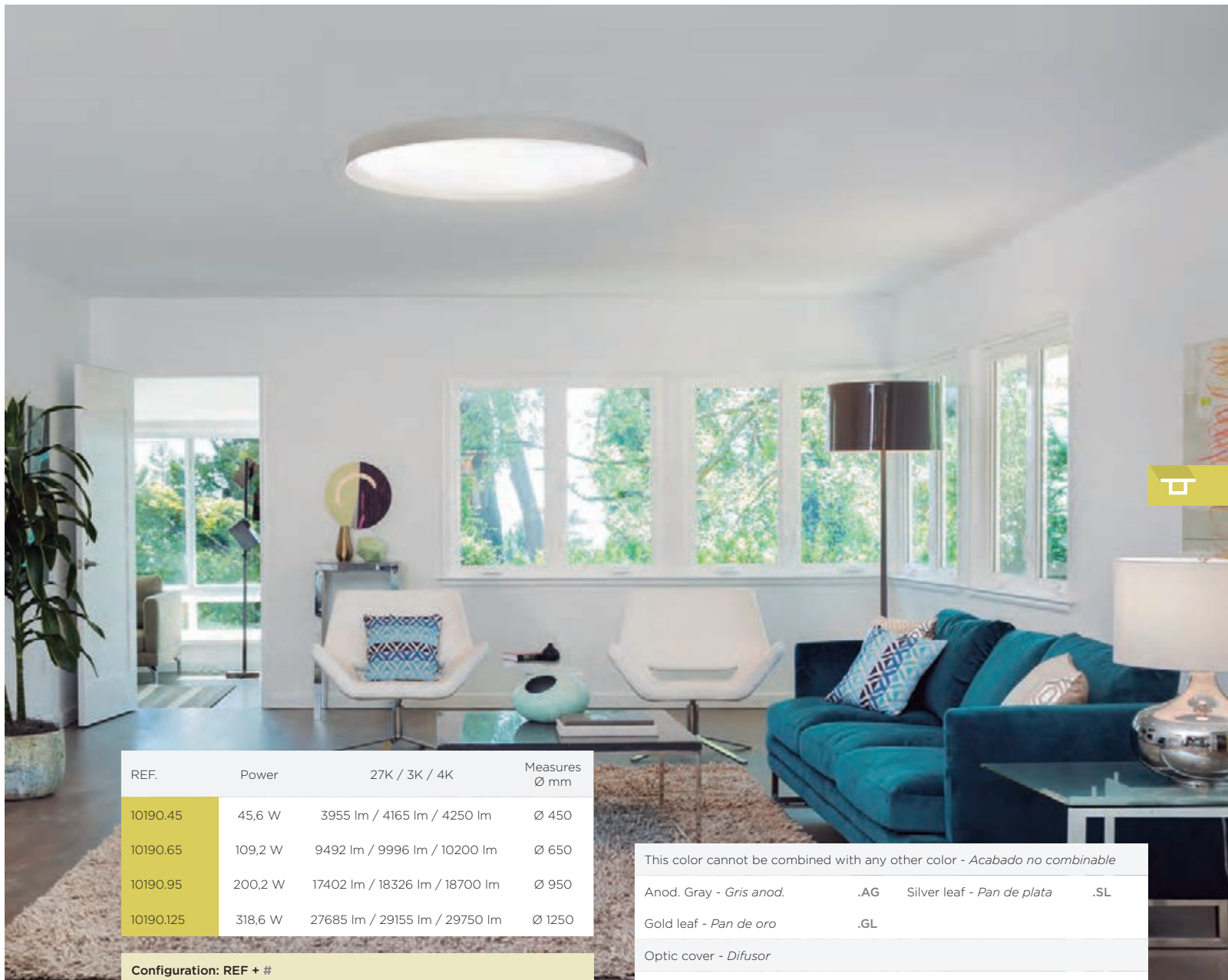

REF.	Power	27K / 3K / 4K	Measures Ø mm
10190.45	45,6 W	3955 lm / 4165 lm / 4250 lm	Ø 450
10190.65	109,2 W	9492 lm / 9996 lm / 10200 lm	Ø 650
10190.95	200,2 W	17402 lm / 18326 lm / 18700 lm	Ø 950
10190.125	318,6 W	27685 lm / 29155 lm / 29750 lm	Ø 1250

Configuration: REF + #			
Installation - <i>Instalación</i>			
Surface <i>Superficie</i>	.SR	Pendant <i>Colgante</i>	.PN
Color finish - <i>Acabados</i>			
Outside - <i>Exterior</i>			
White - <i>Blanco</i>	.W	Black - <i>Negro</i>	.BK
Inside - <i>Interior</i>			
White - <i>Blanco</i>	-W	Black - <i>Negro</i>	-BK
Pink - <i>Rosa</i>	-PI	Gold - <i>Oro</i>	-G
Blue - <i>Azul</i>	-BL	Aqua	-AQ
Red - <i>Rojo</i>	-RE	Flamingo - <i>Flamenco</i>	-FL
Green - <i>Verde</i>	-GR	Orange - <i>Naranja</i>	-OR
Anodized Gray - <i>Gris anodizadi</i>	-AG	Copper - <i>Cobre</i>	-CO

This color cannot be combined with any other color - <i>Acabado no combinable</i>			
Anod. Gray - <i>Gris anod.</i>	.AG	Silver leaf - <i>Pan de plata</i>	.SL
Gold leaf - <i>Pan de oro</i>	.GL		
Optic cover - <i>Difusor</i>			
Opal	.OP	Microprismatic	.MP
Dynamic Light - <i>Luz Dinámica</i>			
Dynamic White <i>Blanco dinámico / pag. 64</i>	.DW	RGB / <i>pag. 59</i>	.RGB
Color Temperature - <i>Temperatura de color</i>			
2700K	.27K	3000K	.3K
4000K	.4K		
Dimmable options - <i>Opciones de regulación</i>			
1..10V	.D1	DALI	.DA
Push - <i>Pulsador</i>	.PU		
Optional indirect light* - <i>Luz indirecta opcional*</i>			
Standard power <i>Potencia estándar</i>	.IN7	High power <i>Alta potencia</i>	.IN12

\*Only Pendant. *Sólo en instalaciones Colgante.*

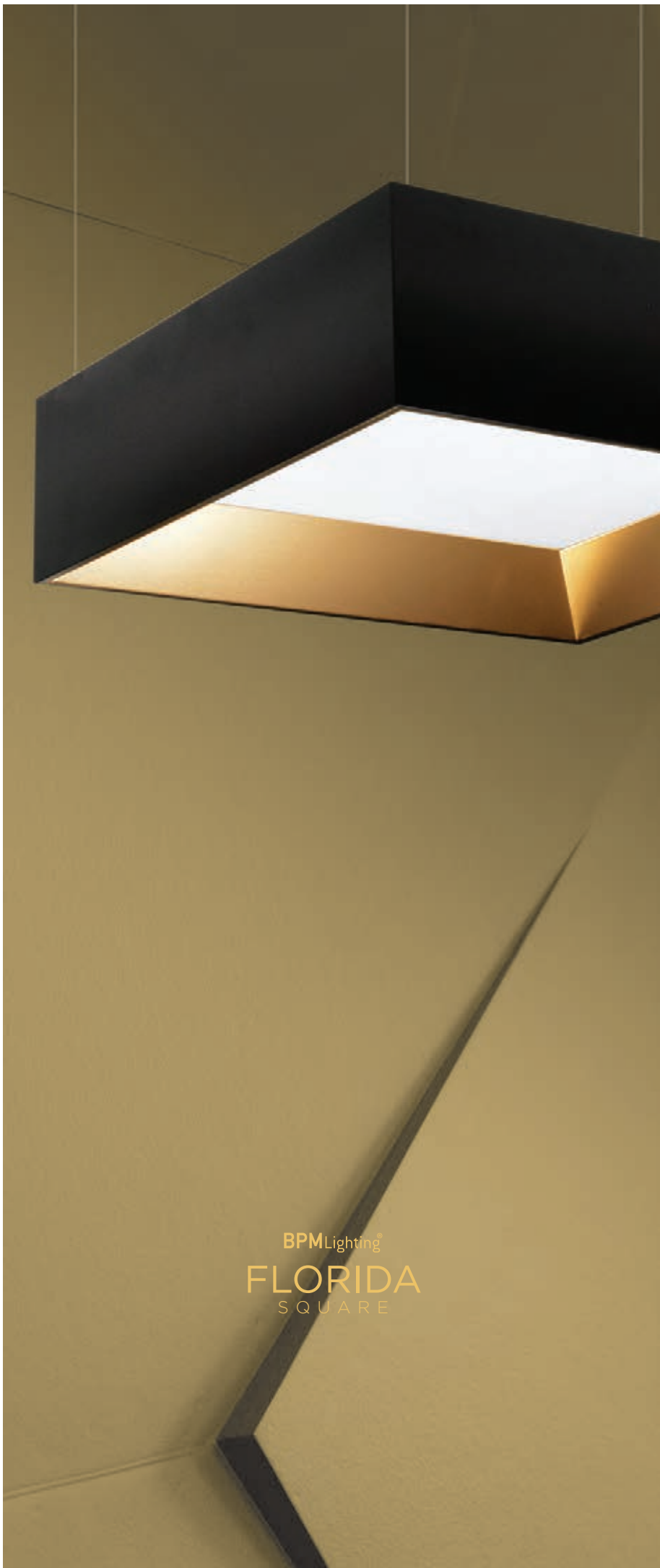

BPMLighting®  
**FLORIDA**  
 SQUARE

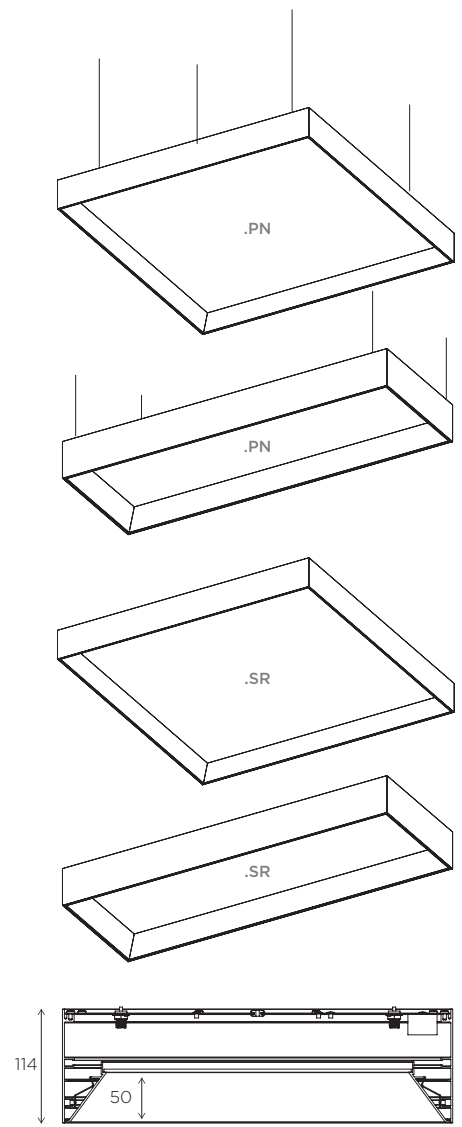

Configuration | Configuración

Indirect light - Luz indirecta, pag. 112

**CONNECTION BOX - CAJA DE CONEXIÓN** pag. 422



CB01

**PHOTOMETRY - FOTOMETRÍA**

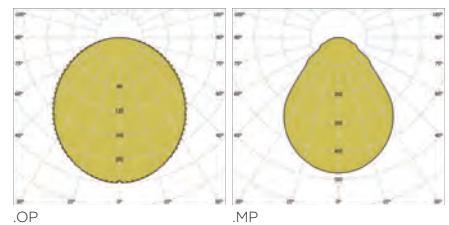

.OP

.MP



You can find all photometry data in our web.

*Puedes encontrar todas las fotometrías en nuestra web.*

**OTHER INSTALLATION - OTRA INSTALACIÓN**

.TR

PAG.82

.RF

PAG. 290

# FLORIDA SQUARE

REF. 10191

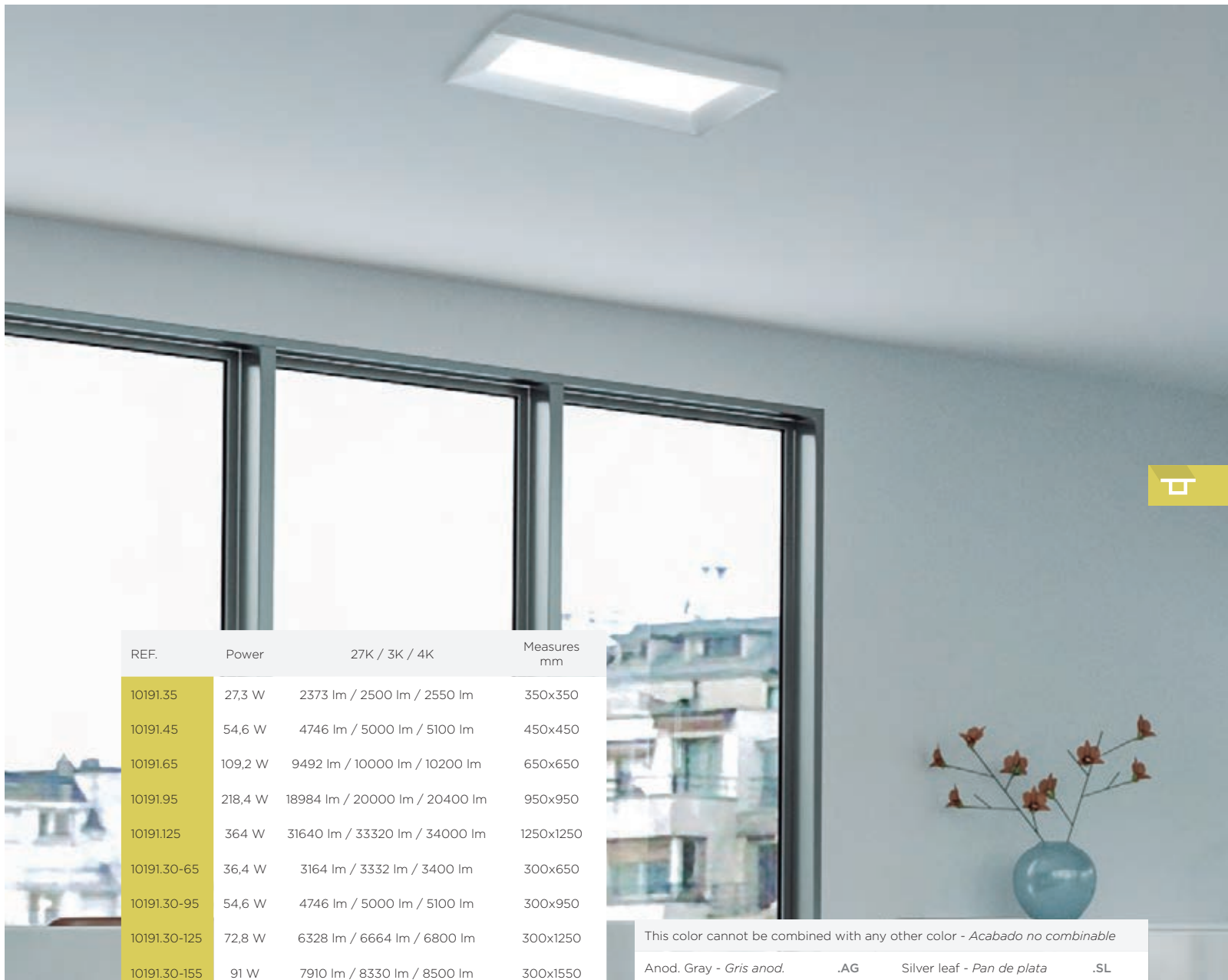

REF.	Power	27K / 3K / 4K	Measures mm
10191.35	27,3 W	2373 lm / 2500 lm / 2550 lm	350x350
10191.45	54,6 W	4746 lm / 5000 lm / 5100 lm	450x450
10191.65	109,2 W	9492 lm / 10000 lm / 10200 lm	650x650
10191.95	218,4 W	18984 lm / 20000 lm / 20400 lm	950x950
10191.125	364 W	31640 lm / 33320 lm / 34000 lm	1250x1250
10191.30-65	36,4 W	3164 lm / 3332 lm / 3400 lm	300x650
10191.30-95	54,6 W	4746 lm / 5000 lm / 5100 lm	300x950
10191.30-125	72,8 W	6328 lm / 6664 lm / 6800 lm	300x1250
10191.30-155	91 W	7910 lm / 8330 lm / 8500 lm	300x1550

Configuration: REF + #			
Installation - <i>Instalación</i>			
Surface <i>Superficie</i>	.SR	Pendant <i>Colgante</i>	.PN
Color finish - <i>Acabados</i>			
Outside - <i>Exterior</i>			
White - <i>Blanco</i>	.W	Black - <i>Negro</i>	.BK
Inside - <i>Interior</i>			
White - <i>Blanco</i>	-W	Black - <i>Negro</i>	-BK
Pink - <i>Rosa</i>	-PI	Gold - <i>Oro</i>	-G
Blue - <i>Azul</i>	-BL	Aqua	-AQ
Red - <i>Rojo</i>	-RE	Flamingo - <i>Flamenco</i>	-FL
Green - <i>Verde</i>	-GR	Orange - <i>Naranja</i>	-OR
Anodized Gray - <i>Gris Anodizado</i>	-AG	Copper - <i>Cobre</i>	-CO

This color cannot be combined with any other color - *Acabado no combinable*

Anod. Gray - *Gris anod.* .AG Silver leaf - *Pan de plata* .SL

Gold leaf - *Pan de oro* .GL

Optic cover - *Difusor*

Opal .OP Microprismatic .MP

Dynamic Light - *Luz Dinámica*

Dynamic White  
*Blanco dinámico / pag. 64* .DW RGB / *pag. 59* .RGB

Color Temperature - *Temperatura de color*

2700K .27K 3000K .3K

4000K .4K

Dimmable options - *Opciones de regulación*

1..10V .D1 DALI .DA

Push - *Pulsador* .PU

Optional indirect light\* - *Luz indirecta opcional\**

Standard power  
*Potencia estándar* .IN7 High power  
*Alta potencia* .IN12

\*Only Pendant. *Sólo en instalaciones Colgante.*





BPMLighting®  
FLORIDA

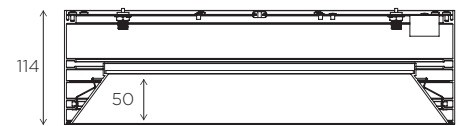
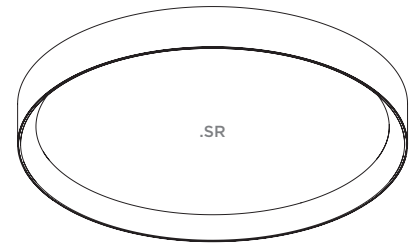
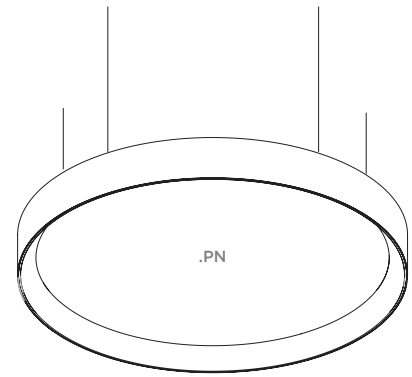

Configuration | Configuración  
Indirect light - Luz indirecta, pag. 112

CONNECTION BOX - CAJA DE CONEXIÓN pag. 422



CB03

PHOTOMETRY - FOTOMETRÍA

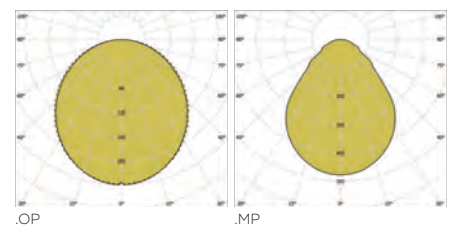

You can find all photometry data in our web.  
Puedes encontrar todas las fotometrías en nuestra web.

OTHER INSTALLATION - OTRA INSTALACIÓN

.TR

PAG. 80

.RF

PAG. 288

# FLORIDA

REF. 10190

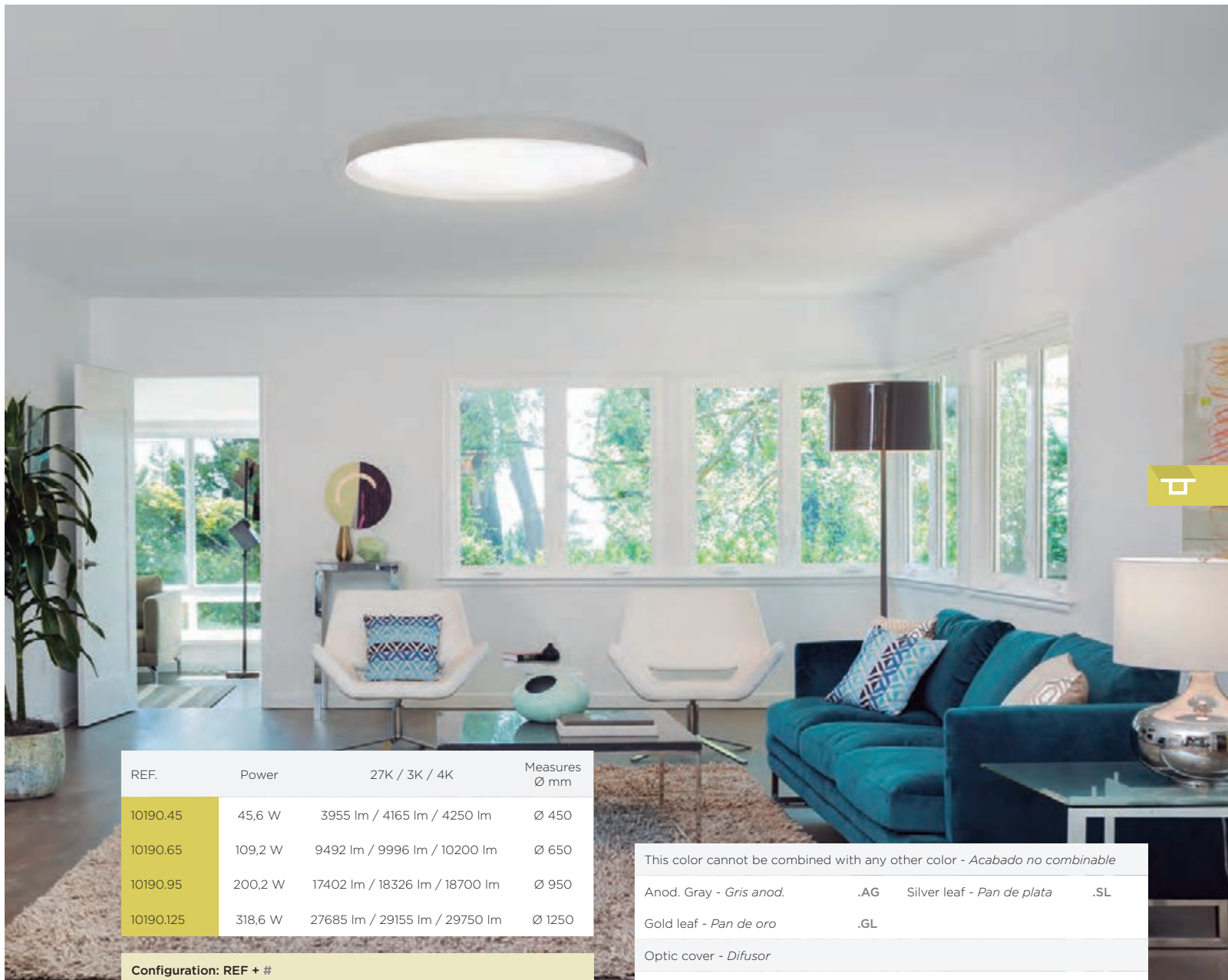

REF.	Power	27K / 3K / 4K	Measures Ø mm
10190.45	45,6 W	3955 lm / 4165 lm / 4250 lm	Ø 450
10190.65	109,2 W	9492 lm / 9996 lm / 10200 lm	Ø 650
10190.95	200,2 W	17402 lm / 18326 lm / 18700 lm	Ø 950
10190.125	318,6 W	27685 lm / 29155 lm / 29750 lm	Ø 1250

Configuration: REF + #			
Installation - <i>Instalación</i>			
Surface <i>Superficie</i>	.SR	Pendant <i>Colgante</i>	.PN
Color finish - <i>Acabados</i>			
Outside - <i>Exterior</i>			
White - <i>Blanco</i>	.W	Black - <i>Negro</i>	.BK
Inside - <i>Interior</i>			
White - <i>Blanco</i>	-W	Black - <i>Negro</i>	-BK
Pink - <i>Rosa</i>	-PI	Gold - <i>Oro</i>	-G
Blue - <i>Azul</i>	-BL	Aqua	-AQ
Red - <i>Rojo</i>	-RE	Flamingo - <i>Flamenco</i>	-FL
Green - <i>Verde</i>	-GR	Orange - <i>Naranja</i>	-OR
Anodized Gray - <i>Gris anodizadi</i>	-AG	Copper - <i>Cobre</i>	-CO

This color cannot be combined with any other color - <i>Acabado no combinable</i>			
Anod. Gray - <i>Gris anod.</i>	.AG	Silver leaf - <i>Pan de plata</i>	.SL
Gold leaf - <i>Pan de oro</i>	.GL		
Optic cover - <i>Difusor</i>			
Opal	.OP	Microprismatic	.MP
Dynamic Light - <i>Luz Dinámica</i>			
Dynamic White <i>Blanco dinámico / pag. 64</i>	.DW	RGB / <i>pag. 59</i>	.RGB
Color Temperature - <i>Temperatura de color</i>			
2700K	.27K	3000K	.3K
4000K	.4K		
Dimmable options - <i>Opciones de regulación</i>			
1..10V	.D1	DALI	.DA
Push - <i>Pulsador</i>	.PU		
Optional indirect light* - <i>Luz indirecta opcional*</i>			
Standard power <i>Potencia estándar</i>	.IN7	High power <i>Alta potencia</i>	.IN12

\*Only Pendant. *Sólo en instalaciones Colgante.*

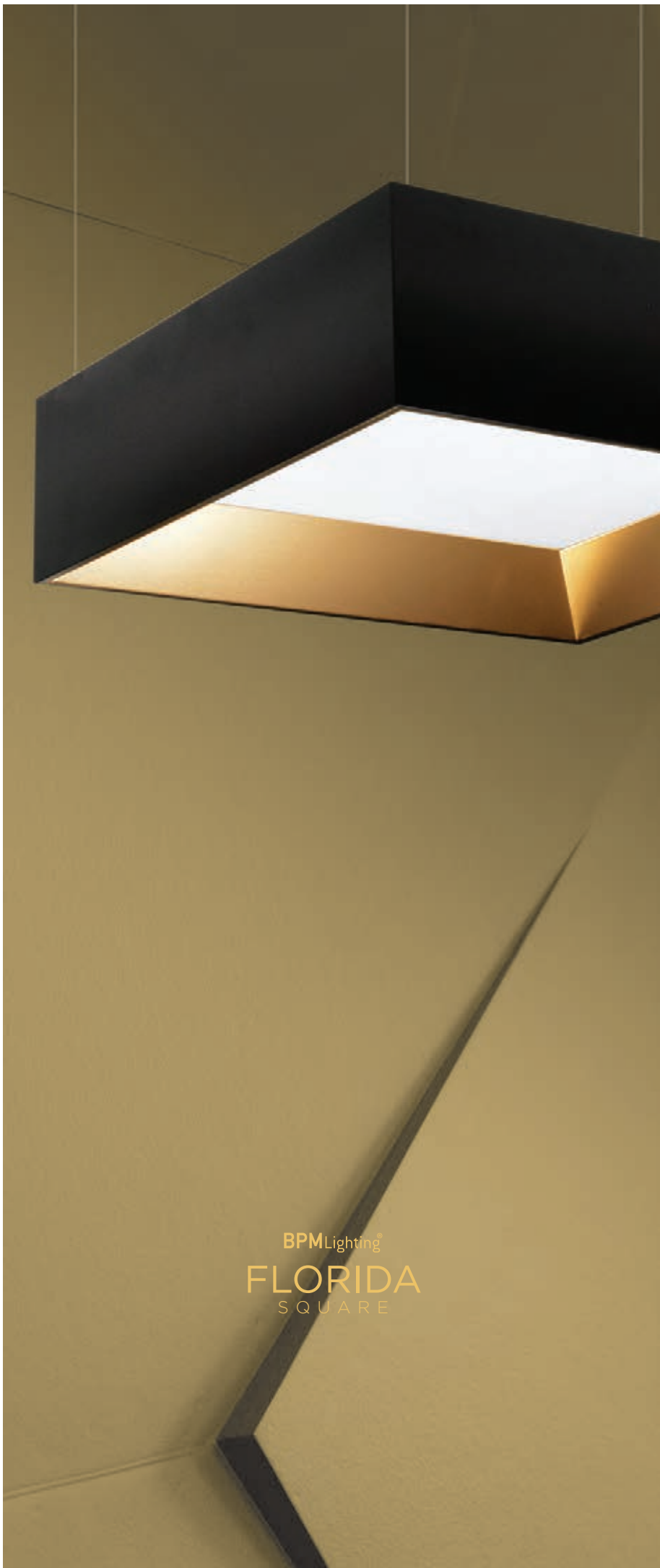

BPMLighting®  
**FLORIDA**  
 SQUARE

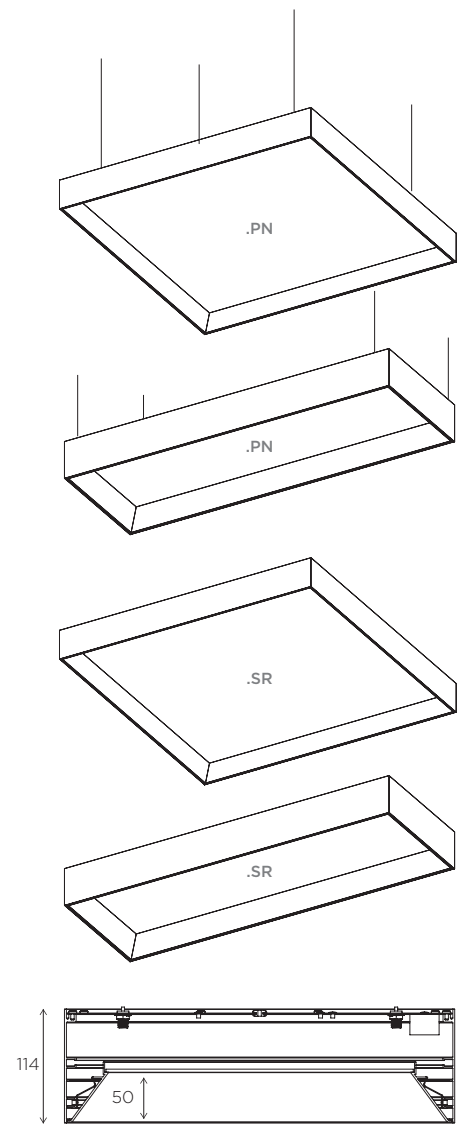

Configuration | Configuración

Indirect light - Luz indirecta, pag. 112

**CONNECTION BOX - CAJA DE CONEXIÓN** pag. 422



CB01

**PHOTOMETRY - FOTOMETRÍA**

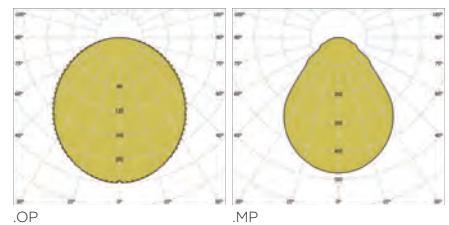

.OP

.MP



You can find all photometry data in our web.

*Puedes encontrar todas las fotometrías en nuestra web.*

**OTHER INSTALLATION - OTRA INSTALACIÓN**

.TR

PAG.82

.RF

PAG. 290

# FLORIDA SQUARE

REF. 10191

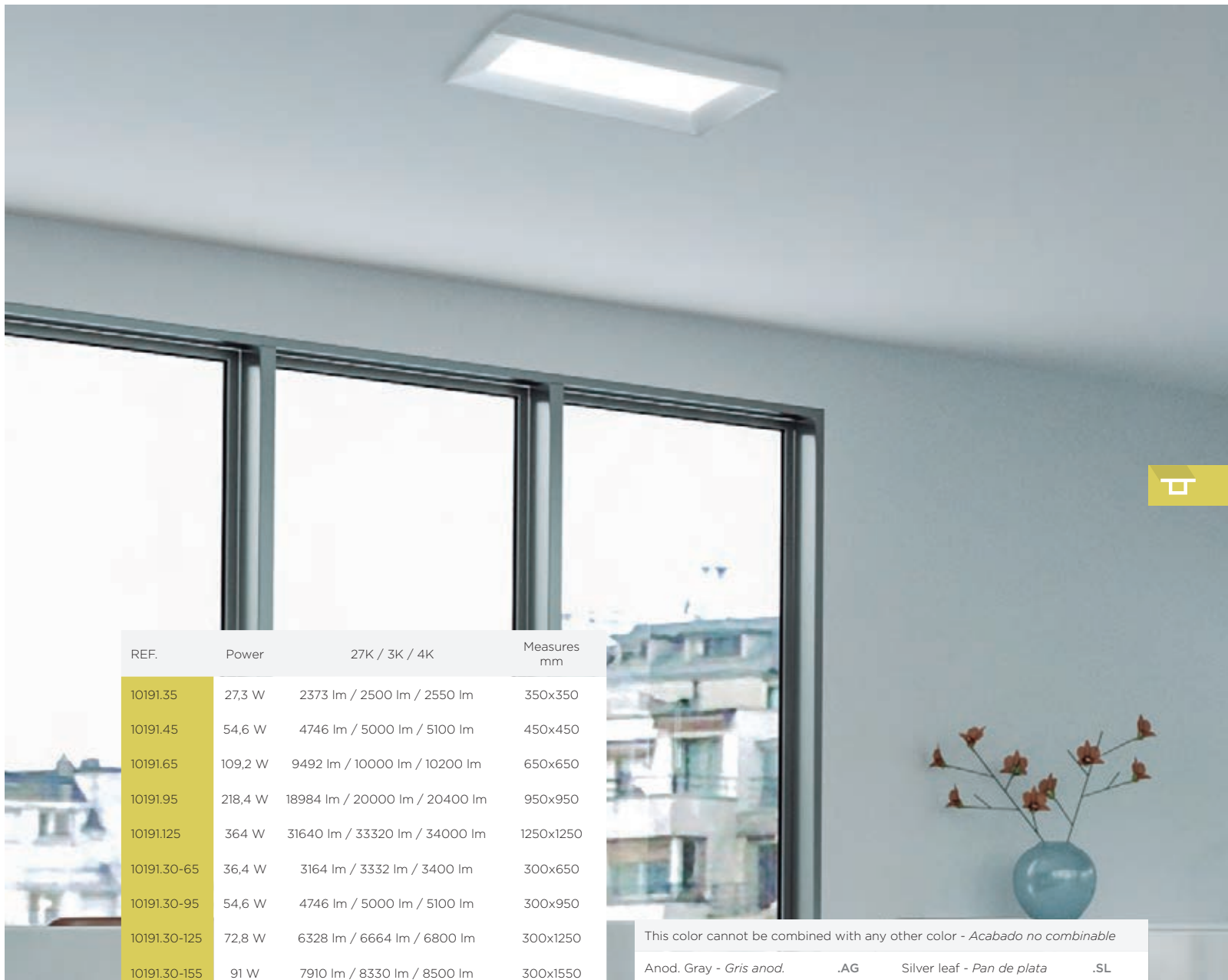

REF.	Power	27K / 3K / 4K	Measures mm
10191.35	27,3 W	2373 lm / 2500 lm / 2550 lm	350x350
10191.45	54,6 W	4746 lm / 5000 lm / 5100 lm	450x450
10191.65	109,2 W	9492 lm / 10000 lm / 10200 lm	650x650
10191.95	218,4 W	18984 lm / 20000 lm / 20400 lm	950x950
10191.125	364 W	31640 lm / 33320 lm / 34000 lm	1250x1250
10191.30-65	36,4 W	3164 lm / 3332 lm / 3400 lm	300x650
10191.30-95	54,6 W	4746 lm / 5000 lm / 5100 lm	300x950
10191.30-125	72,8 W	6328 lm / 6664 lm / 6800 lm	300x1250
10191.30-155	91 W	7910 lm / 8330 lm / 8500 lm	300x1550

Configuration: REF + #			
Installation - <i>Instalación</i>			
Surface <i>Superficie</i>	.SR	Pendant <i>Colgante</i>	.PN
Color finish - <i>Acabados</i>			
Outside - <i>Exterior</i>			
White - <i>Blanco</i>	.W	Black - <i>Negro</i>	.BK
Inside - <i>Interior</i>			
White - <i>Blanco</i>	-W	Black - <i>Negro</i>	-BK
Pink - <i>Rosa</i>	-PI	Gold - <i>Oro</i>	-G
Blue - <i>Azul</i>	-BL	Aqua	-AQ
Red - <i>Rojo</i>	-RE	Flamingo - <i>Flamenco</i>	-FL
Green - <i>Verde</i>	-GR	Orange - <i>Naranja</i>	-OR
Anodized Gray - <i>Gris Anodizado</i>	-AG	Copper - <i>Cobre</i>	-CO

This color cannot be combined with any other color - *Acabado no combinable*

Anod. Gray - *Gris anod.* .AG Silver leaf - *Pan de plata* .SL

Gold leaf - *Pan de oro* .GL

Optic cover - *Difusor*

Opal .OP Microprismatic .MP

Dynamic Light - *Luz Dinámica*

Dynamic White  
*Blanco dinámico / pag. 64* .DW RGB / *pag. 59* .RGB

Color Temperature - *Temperatura de color*

2700K .27K 3000K .3K

4000K .4K

Dimmable options - *Opciones de regulación*

1..10V .D1 DALI .DA

Push - *Pulsador* .PU

Optional indirect light\* - *Luz indirecta opcional\**

Standard power  
*Potencia estándar* .IN7 High power  
*Alta potencia* .IN12

\*Only Pendant. *Sólo en instalaciones Colgante.*