

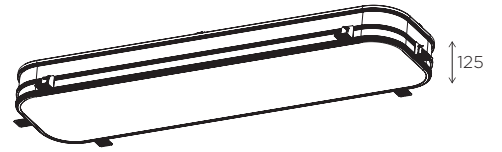

BPM Lighting®  
**ALTAIR**  
TRIMLESS

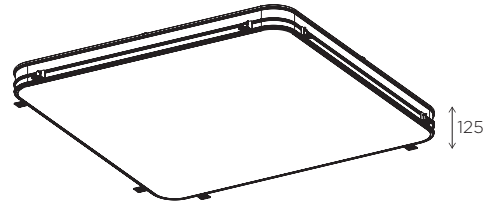

#### PHOTOMETRY - FOTOMETRÍA

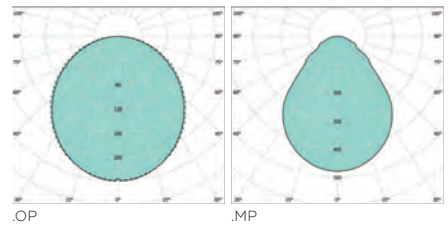

#### OTHER INSTALLATION - OTRA INSTALACIÓN

.PN / .SR PAG. 136



You can find all photometry data in our web.

*Puedes encontrar todas las fotometrías en nuestra web.*

# ALTAIR

REF. 10172

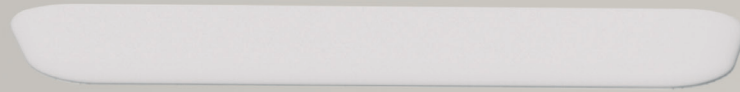

REF.	Power	27K / 3K / 4K	Measures mm	mm
10172.45.STD	24 W	2404 lm / 2552 lm / 2648 lm	393x393	403x403
10172.45.HI	48 W	4808 lm / 5104 lm / 5300 lm		
10172.65.STD		4808 lm / 5104 lm / 5296 lm	593x593	603x603
10172.65.HI	96 W	9616 lm / 10208 lm / 10600 lm		
10172.95.STD	90 W	9015 lm / 9570 lm / 9930 lm	893x893	903x903
10172.95.HI	180 W	18030 lm / 19140 lm / 19875 lm		
10172.125.STD	144 W	14424 lm / 15312 lm / 15888 lm	1193x1193	1203x1203
10172.125.HI	288 W	28848 lm / 30624 lm / 31800 lm		
10172.30-65.STD	24 W	2404 lm / 2552 lm / 2648 lm	283x593	293x603
10172.30-65.HI	48 W	4808 lm / 5104 lm / 5300 lm		
10172.30-95.STD	36 W	3606 lm / 3828 lm / 3972 lm	283x893	293x903
10172.30-95.HI	72 W	7212 lm / 7656 lm / 7950 lm		
10172.30-125.STD	48 W	4808 lm / 5104 lm / 5300 lm	283x1193	293x1203
10172.30-125.HI	96 W	9616 lm / 10208 lm / 10600 lm		
10172.30-155.STD	60 W	6010 lm / 6380 lm / 6620 lm	283x1493	293x1503
10172.30-155.HI	120 W	12020 lm / 12760 lm / 13250 lm		

Configuration: REF + #			
Installation - <i>Instalación</i>			
Trimless <i>Empotrado sin marco</i>		.TR	
Optic cover - <i>Difusor</i>			
Opal	.OP	Microprismatic	.MP
Dynamic Light - <i>Luz Dinámica</i>			
Dynamic White <i>Blanco dinámico / pag. 59</i>	.DW	RGB / <i>pag. 65</i>	.RGB
Color Temperature - <i>Temperatura de color</i>			
2700K	.27K	3000K	.3K
4000K	.4K		
Dimmable options - <i>Opciones de regulación</i>			
1.10V	.D1	DALI	.DA
Push - <i>Pulsador</i>	.PU		



BPMLighting®  
ALTAIR

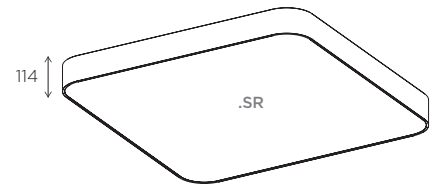
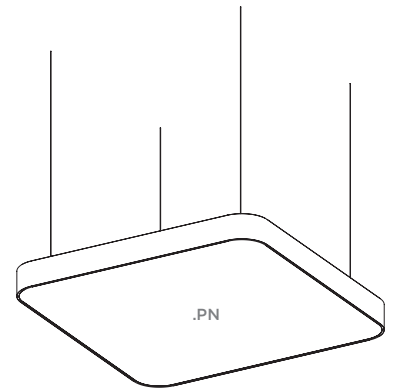

Configuration | Configuración

Indirect light - Luz indirecta, pag. 112

CONNECTION BOX - CAJA DE CONEXIÓN pag. 422



CB03

PHOTOMETRY - FOTOMETRÍA

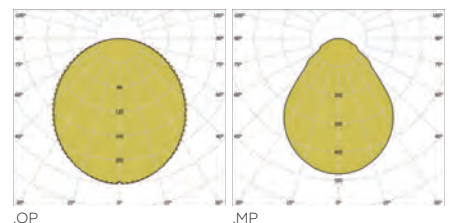

.OP

.MP



You can find all photometry data in our web.

*Puedes encontrar todas las fotometrías en nuestra web.*

OTHER INSTALLATION - OTRA INSTALACIÓN

.TR

PAG. 96

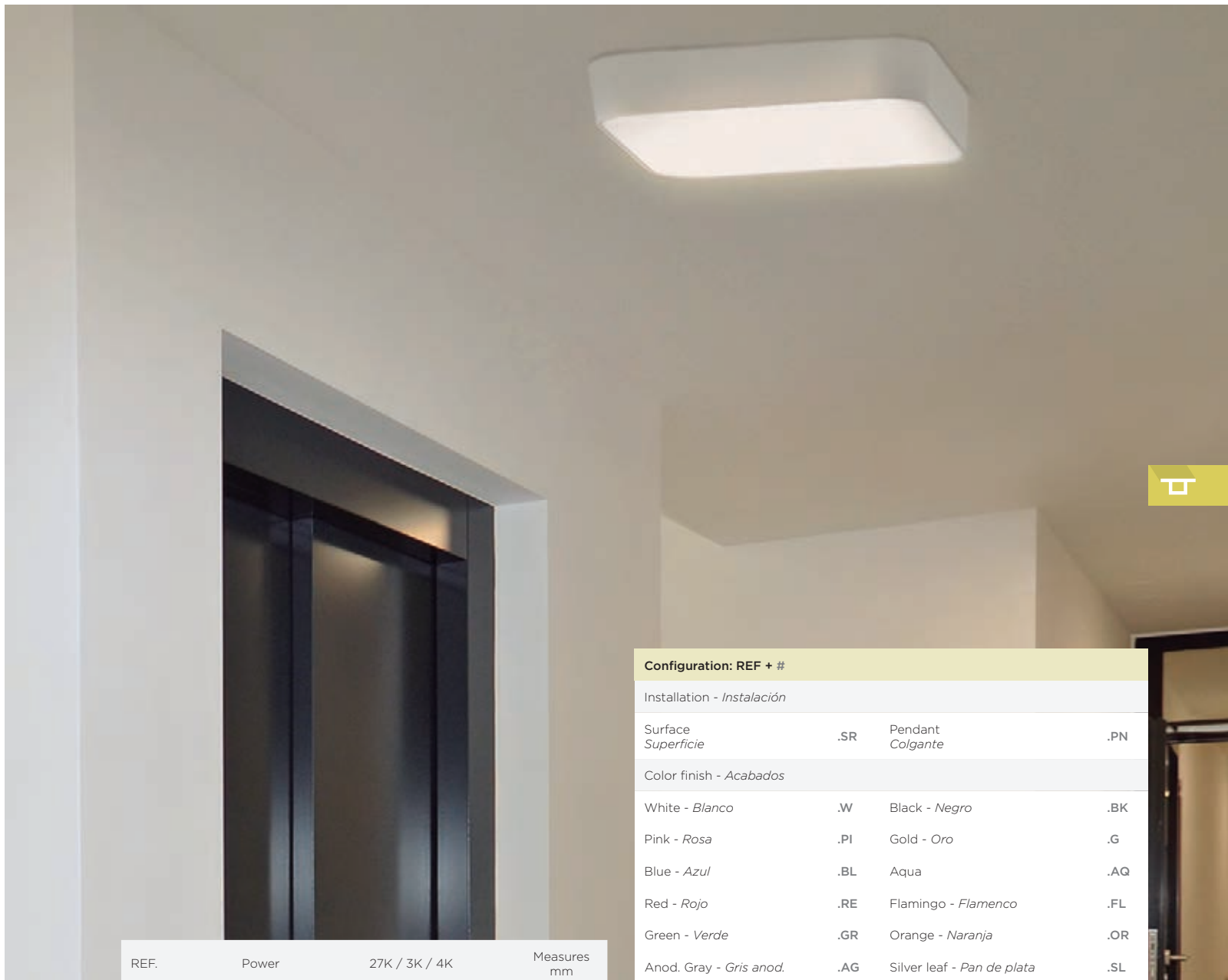

REF.	Power	27K / 3K / 4K	Measures mm
10172.45.STD	24 W	2404 lm / 2552 lm / 2648 lm	400x400
10172.45.HI	48 W	4808 lm / 5104 lm / 5300 lm	
10172.65.STD		48 W	4808 lm / 5104 lm / 5296 lm
10172.65.HI	96 W	9616 lm / 10208 lm / 10600 lm	
10172.95.STD	90 W	9015 lm / 9570 lm / 9930 lm	900x900
10172.95.HI	180 W	18030 lm / 19140 lm / 19875 lm	
10172.125.STD	144 W	14424 lm / 15312 lm / 15888 lm	1200x1200
10172.125.HI	288 W	28848 lm / 30624 lm / 31800 lm	

Configuration: REF + #			
Installation - <i>Instalación</i>			
Surface <i>Superficie</i>	.SR	Pendant <i>Colgante</i>	.PN
Color finish - <i>Acabados</i>			
White - <i>Blanco</i>	.W	Black - <i>Negro</i>	.BK
Pink - <i>Rosa</i>	.PI	Gold - <i>Oro</i>	.G
Blue - <i>Azul</i>	.BL	Aqua	.AQ
Red - <i>Rojo</i>	.RE	Flamingo - <i>Flamenco</i>	.FL
Green - <i>Verde</i>	.GR	Orange - <i>Naranja</i>	.OR
Anod. Gray - <i>Gris anod.</i>	.AG	Silver leaf - <i>Pan de plata</i>	.SL
Gold leaf - <i>Pan de oro</i>	.GL	Copper - <i>Cobre</i>	.CO
Optic cover - <i>Difusor</i>			
Opal	.OP	Microprismatic	.MP
Dynamic Light - <i>Luz Dinámica</i>			
Dynamic White <i>Blanco dinámico / pag. 64</i>	.DW	RGB / <i>pag. 59</i>	.RGB
Color Temperature - <i>Temperatura de color</i>			
2700K	.27K	3000K	.3K
4000K	.4K		
Dimmable options - <i>Opciones de regulación</i>			
1.10V	.D1	DALI	.DA
Push - <i>Pulsador</i>	.PU		
Optional indirect light* - <i>Luz indirecta opcional*</i>			
Standard power <i>Potencia estándar</i>	.IN7	High power <i>Alta potencia</i>	.IN12

\*Only Pendant. Sólo en instalaciones Colgante.



BPMLighting®  
ALTAIR

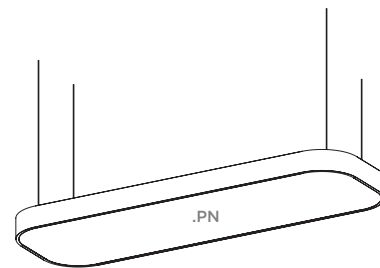

Configuration | Configuración  
Indirect light - Luz indirecta, pag. 112

CONNECTION BOX - CAJA DE CONEXIÓN pag. 422



CB03

PHOTOMETRY - FOTOMETRÍA

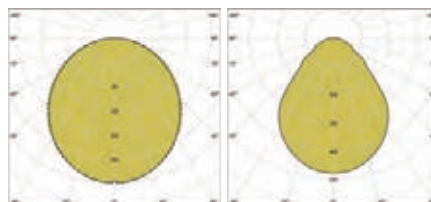

.OP

.MP



You can find all photometry data in our web.

Puedes encontrar todas las fotometrías en nuestra web.

OTHER INSTALLATION - OTRA INSTALACIÓN

.TR

PAG. 96

# ALTAIR

REF. 10172

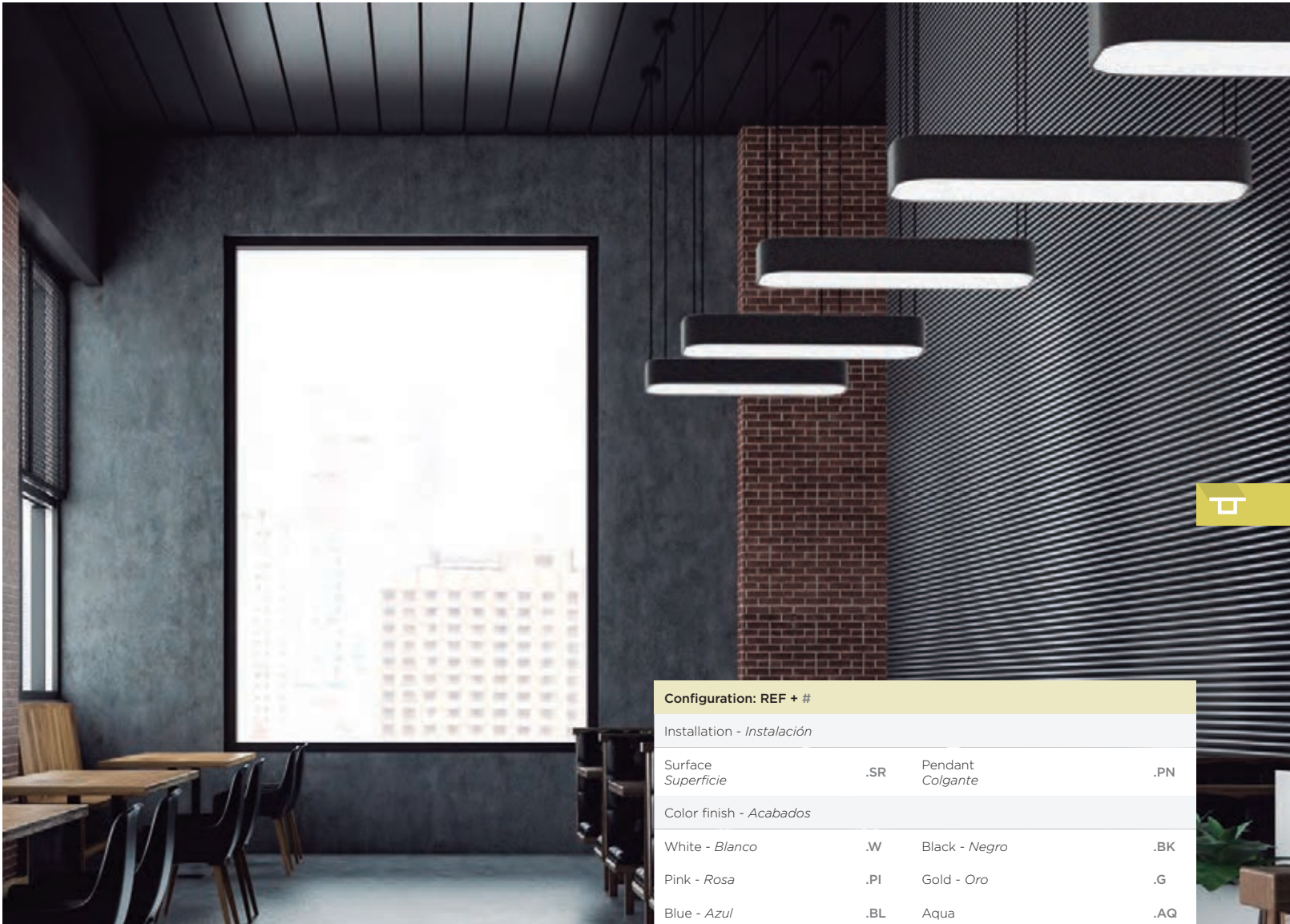

REF.	Power	27K / 3K / 4K	Measures mm
10172.30-65.STD	24 W	2404 lm / 2552 lm / 2648 lm	290x600
10172.30-65.HI	48 W	4808 lm / 5104 lm / 5300 lm	
10172.30-95.STD	36 W	3606 lm / 3828 lm / 3972 lm	290x900
10172.30-95.HI	72 W	7212 lm / 7656 lm / 7950 lm	
10172.30-125.STD	48 W	4808 lm / 5104 lm / 5300 lm	290x1200
10172.30-125.HI	96 W	9616 lm / 10208 lm / 10600 lm	
10172.30-155.STD	60 W	6010 lm / 6380 lm / 6620 lm	290x1500
10172.30-155.HI	120 W	12020 lm / 12760 lm / 13250 lm	

### Configuration: REF + #

#### Installation - *Instalación*

Surface <i>Superficie</i>	.SR	Pendant <i>Colgante</i>	.PN
------------------------------	-----	----------------------------	-----

#### Color finish - *Acabados*

White - <i>Blanco</i>	.W	Black - <i>Negro</i>	.BK
Pink - <i>Rosa</i>	.PI	Gold - <i>Oro</i>	.G
Blue - <i>Azul</i>	.BL	Aqua	.AQ
Red - <i>Rojo</i>	.RE	Flamingo - <i>Flamenco</i>	.FL
Green - <i>Verde</i>	.GR	Orange - <i>Naranja</i>	.OR
Anod. Gray - <i>Gris anod.</i>	.AG	Silver leaf - <i>Pan de plata</i>	.SL
Gold leaf - <i>Pan de oro</i>	.GL	Copper - <i>Cobre</i>	.CO

#### Optic cover - *Difusor*

Opal	.OP	Microprismatic	.MP
------	-----	----------------	-----

#### Dynamic Light - *Luz Dinámica*

Dynamic White <i>Blanco dinámico / pag. 64</i>	.DW	RGB / <i>pag. 59</i>	.RGB
---	-----	----------------------	------

#### Color Temperature - *Temperatura de color*

2700K	.27K	3000K	.3K
4000K	.4K		

#### Dimmable options - *Opciones de regulación*

1..10V	.D1	DALI	.DA
Push - <i>Pulsador</i>	.PU		

#### Optional indirect light\* - *Luz indirecta opcional\**

Standard power <i>Potencia estándar</i>	.IN7	High power <i>Alta potencia</i>	.IN12
--	------	------------------------------------	-------

\*Only Pendant. *Sólo en instalaciones Colgante.*

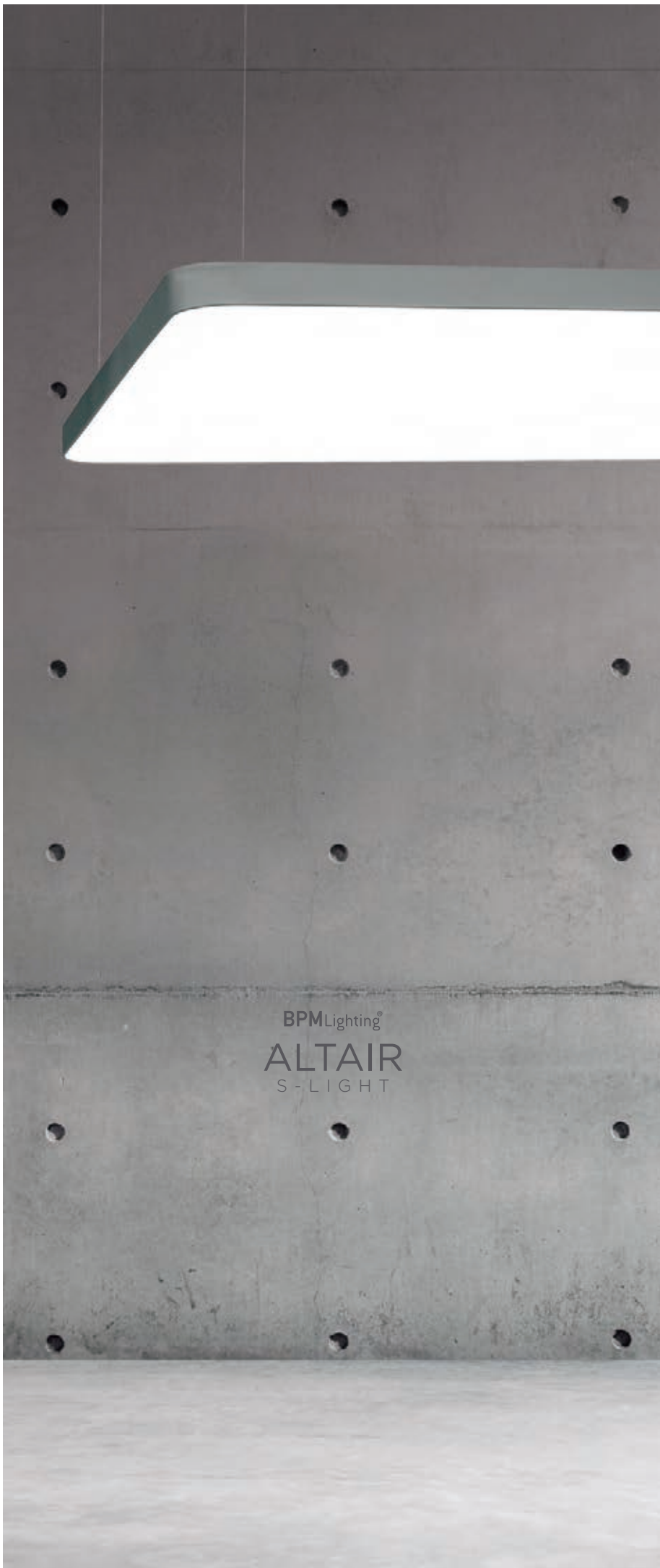

BPMLighting®  
ALTAIR  
S-LIGHT

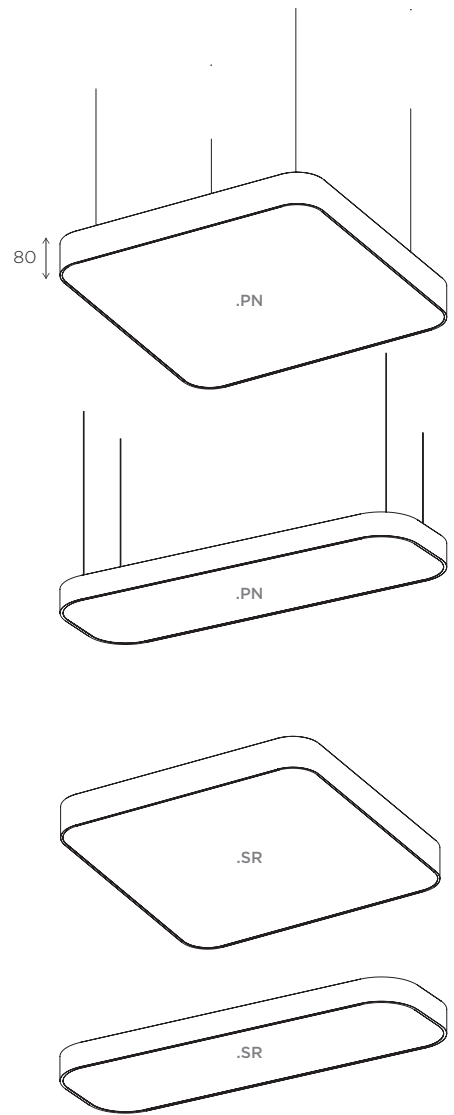

Configuration | Configuración

Indirect light - Luz indirecta, pag. 112

CONNECTION BOX - CAJA DE CONEXIÓN pag. 422



CB03

PHOTOMETRY - FOTOMETRÍA

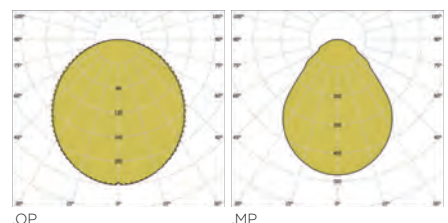

.OP

.MP



You can find all photometry data in our web.

Puedes encontrar todas las fotometrías en nuestra web.

# ALTAIR S-LIGHT

REF. 10199

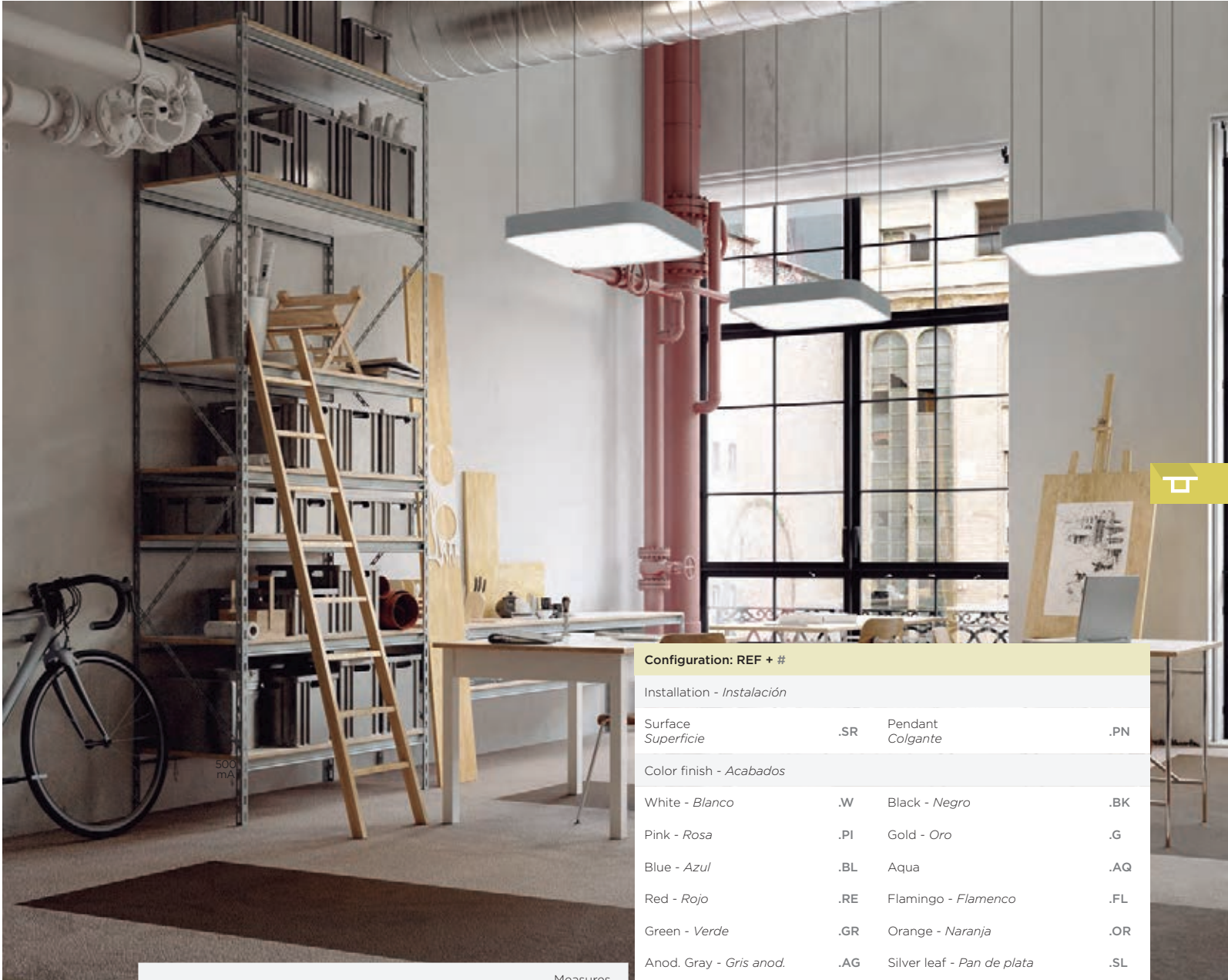

### Configuration: REF + #

#### Installation - Instalación

Surface Superficie	.SR	Pendant Colgante	.PN
-----------------------	-----	---------------------	-----

#### Color finish - Acabados

White - Blanco	.W	Black - Negro	.BK
Pink - Rosa	.PI	Gold - Oro	.G
Blue - Azul	.BL	Aqua	.AQ
Red - Rojo	.RE	Flamingo - Flamenco	.FL
Green - Verde	.GR	Orange - Naranja	.OR
Anod. Gray - Gris anod.	.AG	Silver leaf - Pan de plata	.SL
Gold leaf - Pan de oro	.GL	Copper - Cobre	.CO

#### Optic cover - Difusor

Opal	.OP	Microprismatic	.MP
------	-----	----------------	-----

#### Dynamic Light - Luz Dinámica

Dynamic White Blanco dinámico / pag. 64	.DW	RGB / pag. 59	.RGB
--	-----	---------------	------

#### Color Temperature - Temperatura de color

2700K	.27K	3000K	.3K
4000K	.4K		

#### Dimmable options - Opciones de regulación

1.10V	.D1	DALI	.DA
Push - Pulsador	.PU		

#### Optional indirect light\* - Luz indirecta opcional\*

Standard power Potencia estándar	.IN7	High power Alta potencia	.IN12
-------------------------------------	------	-----------------------------	-------

\*Only Pendant. Sólo en instalaciones Colgante.

REF.	Power	27K / 3K / 4K	Measures mm
10199.35	18 W	1582 lm / 1660 lm / 1700 lm	300x300
10199.45	36,4 W	3164 lm / 3332 lm / 3400 lm	400x400
10199.65	72,8 W	6328 lm / 6664 lm / 6800 lm	600x600
10199.95	136,5 W	11865 lm / 12495 lm / 12750 lm	900x900
10199.125	218,4 W	18984 lm / 20050 lm / 20400 lm	1250x1250
10199.30-65	36,4 W	3164 lm / 3332 lm / 3400 lm	290x600
10199.30-95	54,6 W	4746 lm / 5000 lm / 5100 lm	290x900
10199.30-125	72,8 W	6328 lm / 6664 lm / 6800 lm	290x1200
10199.30-155	91 W	7910 lm / 8330 lm / 8500 lm	290x1500