EN

Fixed steel recessed spotlight, designed for Ø50mm halogen lamps and high performance LED with different diffuser options. Available with single or twin lamps. Provides good visual comfort with light source integrated in installation area. Remote LED driver included and optional dimmable IGBT/TRIAC, 1-10V, PUSH or DALI version available.



VULCANO 1

1-1 | 1-2

RECESSEDS

IP33 EXT

VULCANO 1-1

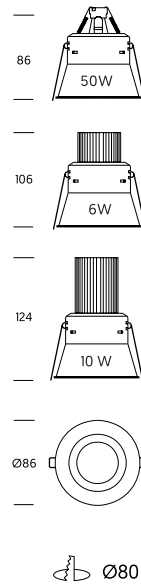

VULCANO 1-2

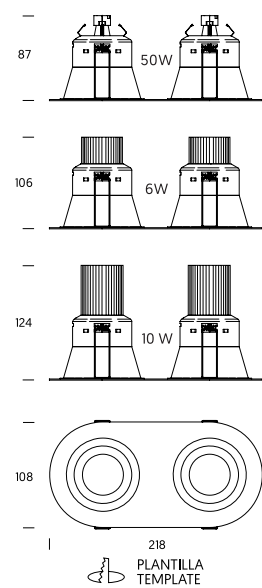

850°

170

VULCANO 1-1

LED	230V	≈ 6W	> 600lm	VL11 A 06	. . . 4 . . .
		≈ 10W	> 1000lm	VL11 A 10	. . . 4 . . .
QR-CBC 51	12V	GU 5.3	50W	VL11 D 50	X X X X . . .
PAR 16	230V	GU 10	50W	VL11 E 50	X X X X . . .

VULCANO 1-2

LED	230V	≈ 6W	> 2 x 600lm	VL12 A 06	. . . 4 . . .
		≈ 10W	> 2 x 1000lm	VL12 A 10	. . . 4 . . .
QR-CBC 51	12V	GU 5.3	2x 50W	VL12 D 50	X X X X . . .
PAR 16	230V	GU 10	2x 50W	VL12 E 50	X X X X . . .

McAdam C3 · >50.000 h. L90 / CRI >80

LED CONTROL

N	No Dimmable	VL1 · A · · N ·
LC	Dimmable IGBT / Triac	VL1 · A · · C ·
PUSH	Dimmable 1-10V / Push	VL1 · A · · F ·
DALI	Dimmable Dali	VL1 · A · · D ·

LED COLOUR TEMPERATURE

3K	3	3000° K	VL1 · A · · . 3 ·
4K	4	4000° K	VL1 · A · · . 4 ·

LED BEAM ANGLE

4	Medium	VL1 · A · · . . . 4 ·
----------	--------	--------------------------------------

LED COMPLEMENTS

B	Clear Difusser	VL1 · A · · B ·
A	Ice Difusser	VL1 · A · · A ·
O	Opal Difusser	VL1 · A · · O ·

COLOURS

WS	WS	Satin White	VL1 · WS
BS	BS	Satin Black	VL1 · BS
AL	AL	Aluminium	VL1 · AL
GD	GD	Gold 24k	VL11 · GD

EN

Adjustable steel recessed spotlight, designed for Ø50mm halogen lamps and high performance LED with different diffuser options. Available with single or twin lamps. Provides good visual comfort with light source integrated in installation area. Remote LED driver included and optional dimmable IGBT/TRIAC, 1-10V, PUSH or DALI version available.



VULCANO 2

2-1 | 2-2

RECESSEDS

IP33 EXT

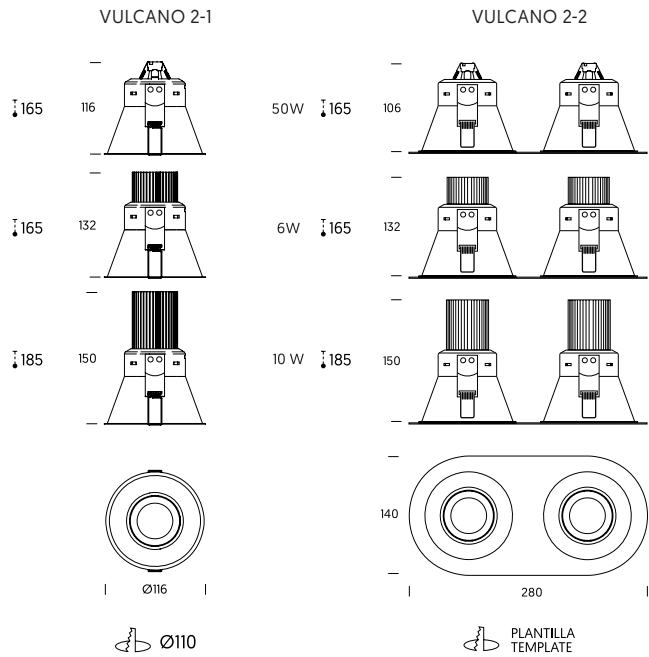

VULCANO 2-1

LED		≈ 6W	> 600lm	VL21 A 06	• • 4 • • •	
		230V				
		≈ 10W	> 1000lm	VL21 A 10	• • 4 • • •	
		12V	GU 5.3	50W	VL21 D 50	X X X X • •
		230V	GU 10	50W	VL21 E 50	X X X X • •

VULCANO 2-2

LED		≈ 6W	> 2 x 600lm	VL22 A 06	• • 4 • • •	
		230V				
		≈ 10W	> 2 x 1000lm	VL22 A 10	• • 4 • • •	
		12V	GU 5.3	2x 50W	VL22 D 50	X X X X • •
		230V	GU 10	2x 50W	VL22 E 50	X X X X • •

McAdam C3 · >50.000 h. L90 / CRI >80

LED CONTROL

	N	No Dimmable	VL2 • A • • N • • • • •
	C	Dimmable IGBT / Triac	VL2 • A • • C • • • • •
	F	Dimmable 1-10V / Push	VL2 • A • • F • • • • •
	D	Dimmable Dali	VL2 • A • • D • • • • •

LED COLOUR TEMPERATURE

	3	3000° K	VL2 • A • • • 3 • • • • •
	4	4000° K	VL2 • A • • • 4 • • • • •

LED BEAM ANGLE

	4	Medium	VL2 • A • • • • • 4 • • • • •
--	----------	--------	--------------------------------------

LED COMPLEMENTS

	B	Clear Difusser	VL2 • A • • • • • B • •
	A	Ice Difusser	VL2 • A • • • • • A • •
	O	Opal Difusser	VL2 • A • • • • • O • •

COLOURS

	WS	Satin White	VL2 • • • • • • WS
	BS	Satin Black	VL2 • • • • • • BS
	AL	Aluminium	VL2 • • • • • • AL
	GD	Gold 24k	VL21 • • • • • • GD

EN

Adjustable steel recessed spotlight, designed for Ø111mm halogen lamps and metal halide lamps or high performance LED. Various diffuser options available and a choice of 3 different beam reflectors. Available with single or twin lamps. Provides good visual comfort with light source integrated in installation area. Remote LED driver included and optional dimmable IGBT/ TRIAC, 1-10V, PUSH or DALI version available.



VULCANO 3

3-1 | 3-2

RECESSEDS

IP23 EXT

VULCANO 3-1

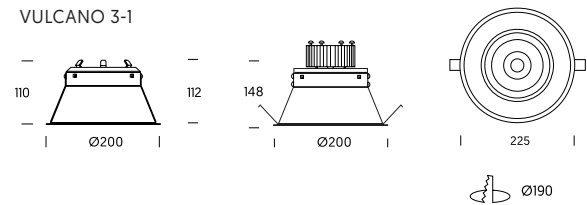

VULCANO 3-2

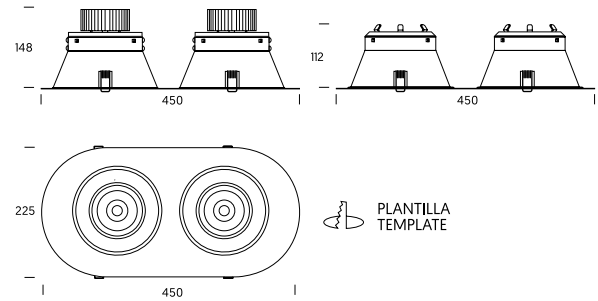

VULCANO 3-1

LED	230V	≈ 8W	> 1200lm	VL31 A 10	• • • X ••
		≈ 18W	> 2400lm	VL31 A 20	• • • X ••
		≈ 24W	> 3200lm	VL31 A 30	• • • X ••
QR-III	12V	G53	100W	VL31 C 1C	X X X X ••
CDM-R111	230V*	Gx8.5	70W	VL31 G 70	X X X X ••

VULCANO 3-2

LED	230V	≈ 8W	> 2 x 1200lm	VL32 A 10	• • • X ••
		≈ 18W	> 2 x 2400lm	VL32 A 20	• • • X ••
		≈ 24W	> 2 x 3200lm	VL32 A 30	• • • X ••
QR-III	12V	G53	2x 100W	VL32 C 1C	X X X X ••
CDM-R111	230V*	Gx8.5	2x 70W	VL32 G 70	X X X X ••

McAdam C3 · >44.000 h. L90 · >69.000 h. L80 · >79.000 h. L70 / CRI >85

LED CONTROL

	N	No Dimmable	VL3• A •• N • • • ••
	F	Dimmable 1-10V / Push	VL3• A •• F • • • ••
	D	Dimmable Dali	VL3• A •• D • • • ••

LED COLOUR TEMPERATURE

	3	3000° K	VL3• A •• • 3 • • • ••
	4	4000° K	VL3• A •• • 4 • • • ••

LED BEAM ANGLE

	2	Spot	VL3• A •• • • • 2 • • •
	3	Medium	VL3• A •• • • • 3 • • •
	5	Flood	VL3• A •• • • • 5 • • •

LED COMPLEMENTS

	X	No difusser	VL3• A •• • • • X ••
--	----------	-------------	-----------------------------

COLOURS

	WS	Satin White	VL3• • • • • • • WS
	BS	Satin Black	VL3• • • • • • • BS
	AL	Aluminium	VL3• • • • • • • AL
	GD	Gold 24k	VL3• • • • • • • GD



VULCANO 3 LED

RECESSEDS

IP23 EXT



EN

Fixed steel recessed spotlight designed for high performance LED. Provides good visual comfort with light source integrated in installation area. Remote LED driver included and optional dimmable 1-10V, PUSH or DALI version available.

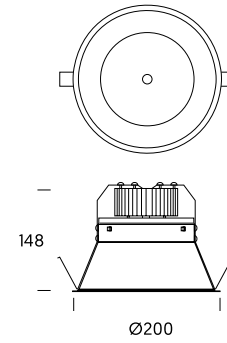

850°

185



Ø190

VULCANO 3 LED



230V

≈ 8W	> 1200lm	VL3L A 10	• • 9 X ••
≈ 18W	> 2400lm	VL3L A 20	• • 9 X ••
≈ 24W	> 3200lm	VL32 A 30	• • 9 X ••

McAdam C3 · >53.000 h. L90 · >78.000 h. L80 · >88.000 h. L70 / CRI >85

LED CONTROL

	N	No Dimmable	VL3L A •• N • • • ••
	F	Dimmable 1-10V / Push	VL3L A •• F • • • ••
	D	Dimmable Dali	VL3L A •• D • • • ••

LED COLOUR TEMPERATURE

	3	3000° K	VL3L A •• • 3 • • • ••
	4	4000° K	VL3L A •• • 4 • • • ••

LED BEAM ANGLE

	9	Expansive	VL3L A •• • • • 9 • •
--	----------	-----------	------------------------------

LED COMPLEMENTS

	X	No Difusser	VL3L A •• • • • X ••
--	----------	-------------	-----------------------------

COLOURS

	WS	Satin White	VL3L A •• • • • • WS
	BS	Satin Black	VL3L A •• • • • • BS
	AL	Aluminium	VL3L A •• • • • • AL



VULCANO G24

3 | 4

RECESSEDS

IP33 EXT



EN

Recessed spot with a soft design made in steel for compact fluorescent lamp. It offers good visual comfort, being integrated to with the installation surface. New and simple system of lamp replacement.

VULCANO 3 G24

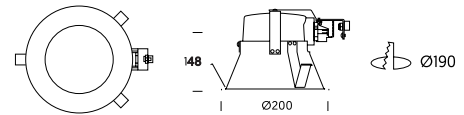

VULCANO 4 G24

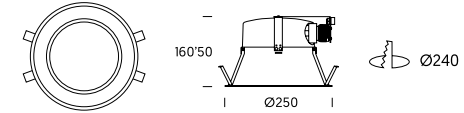

850°

200

VULCANO 3 G24

		230V	G 24-q2	1 x 18W	VL3G	I	GD	•	X	X	G	••
		230V	G 24-q3	1 x 26W	VL3G	I	GE	•	X	X	G	••

VULCANO 4 G24

		230V	G 24-q3	2 x 26W	VL4G	I	GA	•	X	X	G	••
		230V	G 24-q3	2 x 32W	VL4G	I	GF	•	X	X	G	••

CONTROL

	N	No Dimmable	VLG• •• N • • • •
	E	Dimmable 1-10V	VLG• •• E • • • •
	D	Dimmable Dali	VLG• •• D • • • •

COLOUR TEMPERATURE

	X	No Temperature	VLG• •• • X • • •
--	----------	----------------	----------------------------

LED BEAM ANGLE

	X	No Angle	VLG• •• • • X • •
--	----------	----------	----------------------------

LED COMPLEMENTS

	G	Glass Difusser	VLG• • • • • G ••
--	----------	----------------	--------------------------

COLOURS

	WS	Satin White	VLG• •• • • • • WS
	BS	Satin Black	VLG• •• • • • • BS
	AL	Aluminium	VLG• •• • • • • AL



VULCANO ASIM

RECESSEDS



IP33 EXT

EN

Fixed recessed spotlight made of die-casted aluminium, designed for high performance LED with different diffuser options. Provides good visual comfort with light source integrated in installation area. Remote LED driver included and optional dimmable IGBT/TRIAC, 1-10V, PUSH or DALI version available.

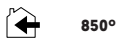
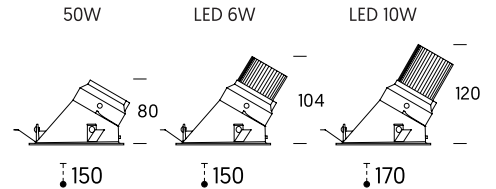

850°



Ø110

VULCANO ASI

LED	230V	≈ 6W	> 600lm	VLAS A 06 . . 4 . .
		≈ 10W	> 1000lm	VLAS A 10 . . 4 . .
QR-CBC 51	12V GU 5.3	50W		VLAS D 50 X X X X . .
PAR 16	230V GU 10	50W		VLAS E 50 X X X X . .

McAdam C3 · >50.000 h. L90 / CRI >80

LED CONTROL

	N	No Dimmable	VLAS A .. N
	C	Dimmable IGBT / Triac	VLAS A .. C
	F	Dimmable 1-10V / Push	VLAS A .. F
	D	Dimmable Dali	VLAS A .. D

LED COLOUR TEMPERATURE

	3	3000° K	VLAS A .. . 3
	4	4000° K	VLAS A .. . 4

LED BEAM ANGLE

	4	Medium	VLAS A 4 . .
--	----------	--------	----------------------------

LED COMPLEMENTS

	B	Clear Difusser	VLAS A B ..
	A	Ice Difusser	VLAS A A ..
	O	Opal Difusser	VLAS A O ..

COLOURS

	WS	Satin White	VLAS WS
	BS	Satin Black	VLAS BS
	GD	Gold 24k	VLAS GD